

CYPRESS

FM FAMILY:

**ARM® CORTEX®-M BASED
MICROCONTROLLERS**

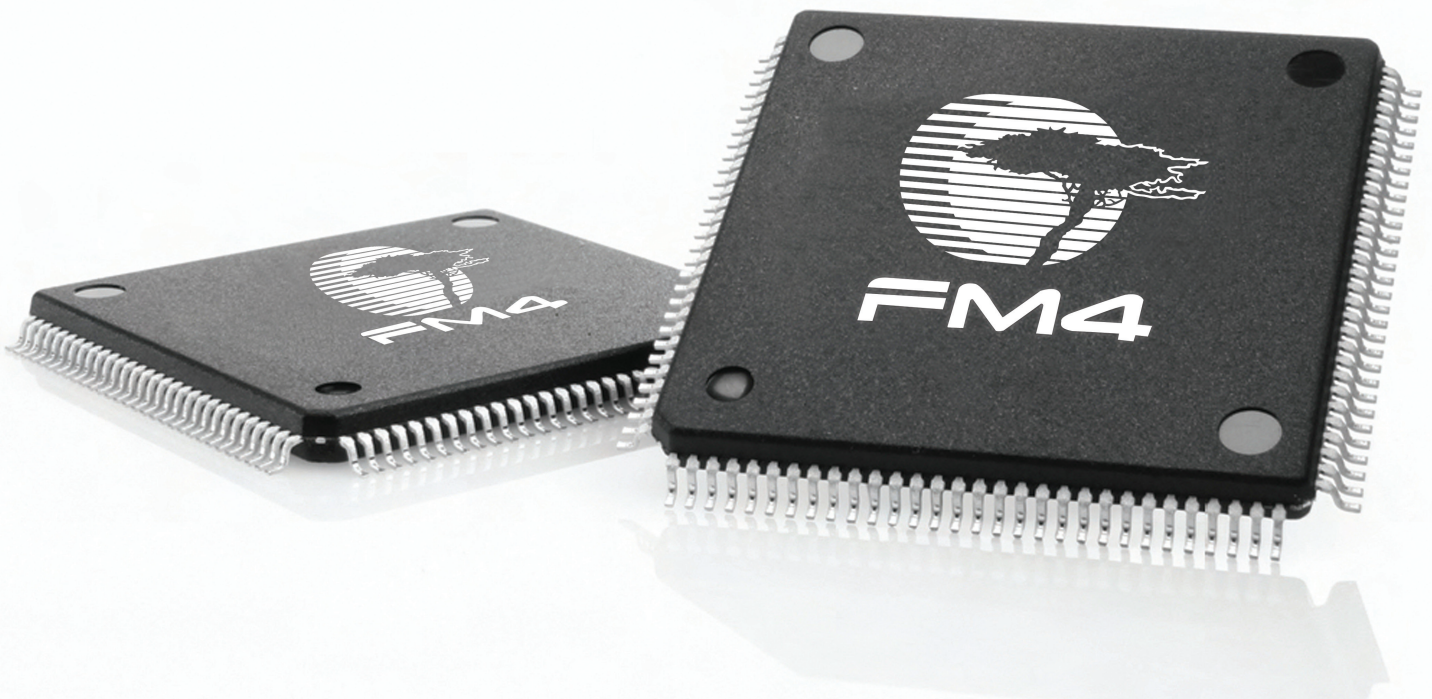

TABLE OF CONTENTS

FM Microcontrollers	3	Package Code	3
FM MCU lineup	5	Development Tools	5
FM4 Family.....	6	FM Family Solutions	6
FM3 Family.....	10	Why Cypress	10
FM0+ Family.....	18		

CORE & CODE

TECHNICAL TIPS FOR SYSTEM DESIGNERS

Core & Code offers technical expertise and content tailored for embedded system designers. Published on a quarterly basis, Core & Code features articles, "how-to" design pieces, application notes, new products and more from Cypress and other industry thought leaders on embedded technologies, products, issues and best practices for designing products in automotive, industrial, consumer and networking markets. This platform provides a forum to share knowledge on the industry and recommendations to ease the design process. Get the latest industry news on our blog, use the All Issues section to explore past articles and browse upcoming industry events to get more involved. Core & Code is powered by Cypress, a global leader in embedded systems solutions.



Visit: <http://core.cypress.com>

CYPRESS® FM MICROCONTROLLERS

The Cypress® FM microcontrollers (MCUs) incorporate the latest ARM® Cortex® standard cores (M0+, M3 and M4), offering users the optimal product for a wide range of industrial and consumer applications. The scalable platform ranges from low-pin-count, low-power microcontrollers to high-performance products with a rich set of peripherals (including CAN, USB and Ethernet) and up to 2MB flash memory. The high-speed, embedded flash process technology offers the endurance of 100K erase/write cycles and up to 20 years of data retention.

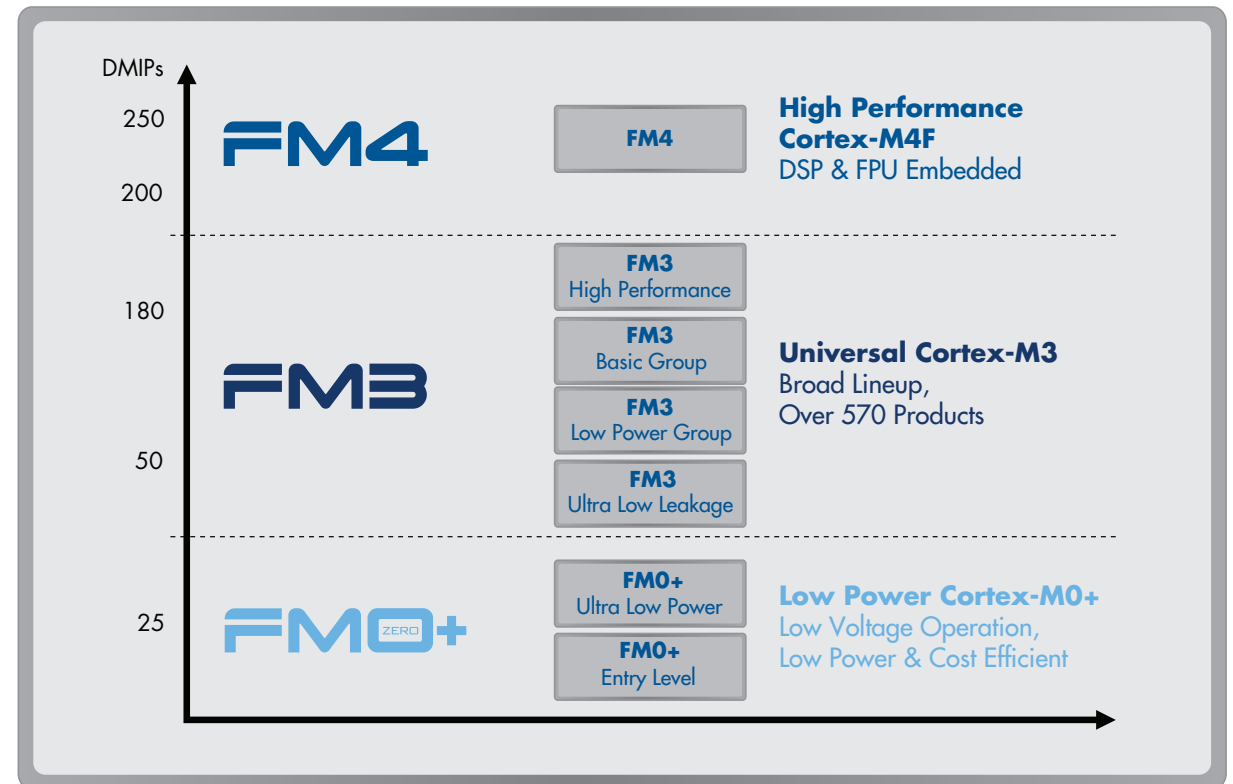

ARM CORTEX-M CPU COMPARISON

	M0	M0+ (used in FM0+)	M3 (used in FM3)	M4 (used in FM4)
Power consumption (CPU)	16µW/MHz	11.2µW/MHz	0.1mW/MHz	-
Performance	0.84 DMIPS/MHz	0.93 DMIPS/MHz	1.25 DMIPS/MHz	Same as M3
IRQs	NMI + 32	NMI + 32	NMI + 240 8-256 levels	Same as M3
Pipeline	3 stage	2 stage	3 stage + branch speculation	Same as M3
Instruction set	Thumb®/Thumb-2 subset	Thumb®/Thumb-2 subset	Thumb®/Thumb-2	Same as M3
Single cycle multiply 32x32	✓	✓	✓	Same as M3
Hardware divided (2-12 cycles)	-	-	✓	Same as M3
Debug	Up to 4 Breakpoints and 2 Watchpoints	Up to 4 Breakpoints and 2 Watchpoints	Up to 8 Breakpoints and 4 Watchpoints	Same as M3
Trace	-	Micro trace buffer	ETM	Same as M3
Bit manipulation	✓	✓	✓	Same as M3
DSP instructions	-	-	-	✓
Single precision FPU	-	-	-	✓

KEY FEATURES

Outstanding Performance

- ARM Cortex-M series core
- High CPU clock frequencies of up to 200MHz (FM4) and 144MHz (FM3)
- Highly reliable, high-speed, secure embedded flash memory
 - True zero-wait-state flash operation at 72MHz
 - Pre-fetch buffer for zero-wait-state operation at 200MHz
- Support for voltages ranging from 1.65-5.5V
 - 1.65-3.6V: low-power products
 - 1.8-5.5V: ultra-low-leakage products
 - 2.7-5.5V: high-performance products
- DMA controller with dedicated bus layer and up to eight independent channels

Functional Safety

- Internal, trimmed RC oscillators as an independent clock source
- Clock supervisor
- Two-stage (interrupt and reset), programmable LVD (low voltage detector)
- CRC hardware module
- MPU (memory protection unit)
- Programmable emergency stop input for PWM motor control
- Self-test library for IEC61508 and IEC60730
- Watchdog timer

High-Performance Flash Memory

- Memory densities up to 2MB flash/256KB RAM
- Highly reliable flash memory
 - 100,000 write/erase cycles endurance
 - Up to 20 years of data retention
- Flash security function
- Dual-operation flash for EEPROM emulation on many devices

Low Power

- Dedicated low-power chip design with clock and power gating
- Multiple low-power options for finely grained power-saving modes
- Dedicated power domain for deep standby modes
- Low-power, low-leakage products for handheld, battery-powered applications

APPLICATIONS

Cypress FM microcontrollers are appropriate for a wide variety of applications, including:

- Industrial
- Motor control and other inverter applications
- Factory automation
- White goods
- Home appliances
- Home automation and sensor control
- Power tools
- Medical and healthcare applications
- Handheld devices

I/O Ports

- Internal pull-up resistors (enable/disable)
- Flexible resource relocation: most peripheral functions can be routed to two or more MCU pins
- 12mA general-purpose IOs
- Readable external pin state

Connectivity

- Up to two channels CAN controller
- CAN-FD controller on some series
- Full-speed USB host/device, up to two channels each
- Up to two channels Ethernet MAC
- Flexible, multi-function serial interfaces covering I²C, SPI (up to 20 Mbps), LIN and UART
 - I²C/SPI/LIN/UART selectable within each channel
- 8/16-bit external bus interface with support for SRAM, NOR-, NAND-flash and SDRAM (FM4)
- HDMI-CEC macro (with IR receive macro)

Advanced Peripherals

- Up to three multifunction timers (for motor control)
 - Includes waveform generator with dead time insertion
 - Includes advanced A/D converter trigger unit
- Quadrature decoder unit for motor-control feedback and HMI input devices, multi-turn capability
- Base timer (PWM, PWC, PPG and reload timer)
- Sub-clock option
- Up to three independent (synchronously triggerable), high-speed 12-bit A/D converters, conversion time: 0.5µs on FM4, 1µs on FM3
- Up to two channels, 12-bit D/A converters

Debug Interface

- JTAG and SWJ debug interfaces
- Embedded trace macro-cell on many devices

CYPRESS FM MCU LINEUP

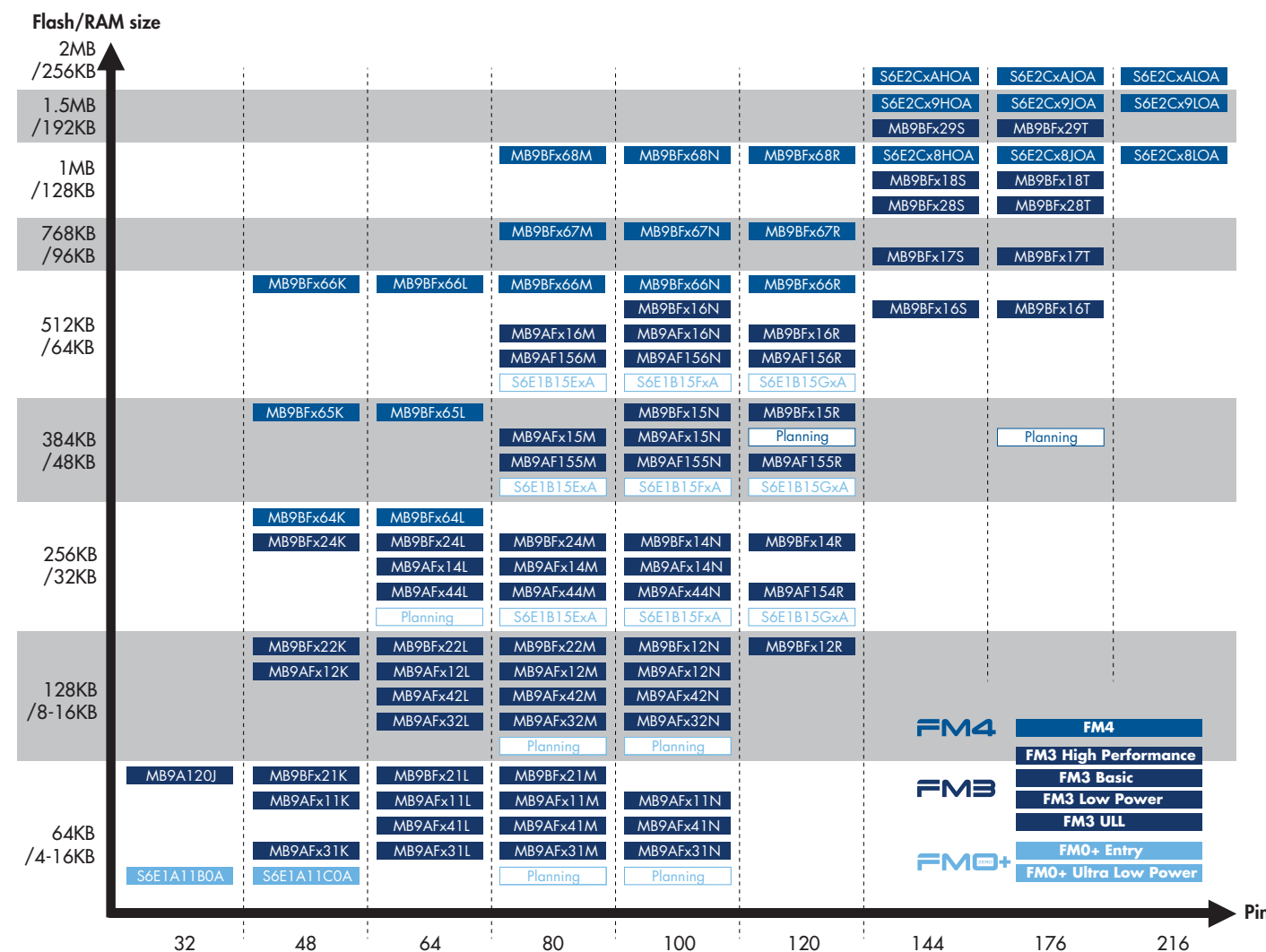

The Cypress FM MCU lineup consists of three families—FM0+, FM3 and FM4—each of which uses a specific ARM Cortex-M core. Users can easily transition between device types and families because of the compatibility of the instruction sets.

CYPRESS FM4 FAMILY

CORTEX-M4 - CORE PRODUCTS HIGH PERFORMANCE

- For industrial applications
- Higher spec with FPU/DSP
- Quadruple performance in arithmetic program (compared with FM3)
- Max frequency: 200MHz
- Operation voltage: 2.7V~5.5V

The FM4 family of 32-bit, general purpose MCUs is based on the ARM CortexM4F processor core. This family, which features DSP and floating point (FPU) functions, covers the highest end of the product range.

The MCUs are designed for applications that require advanced, high-speed computing performance such as general-purpose inverters, servomotors, PLCs and other industrial equipment, as well as inverter-based home appliances such as washing machines and air conditioners.

KEY FEATURES

- Frequency: up to 200MHz
- Operating voltage: 2.7-5.5V
- Low power consumption: 0.4mA/MHz, 1.5uA RTC mode
- Flash: 256KB-2MB
- Up to 256KB RAM
- 48-216 pin packages
- IP: Ethernet, CAN, USB2.0, motor control

MOTOR AND INVERTOR

- High spec vector arithmetic
- Enhanced motor control timer
- High speed sampling A/D converter (conversion speed: 2Msp/s)

FM4 PRODUCT LINEUP

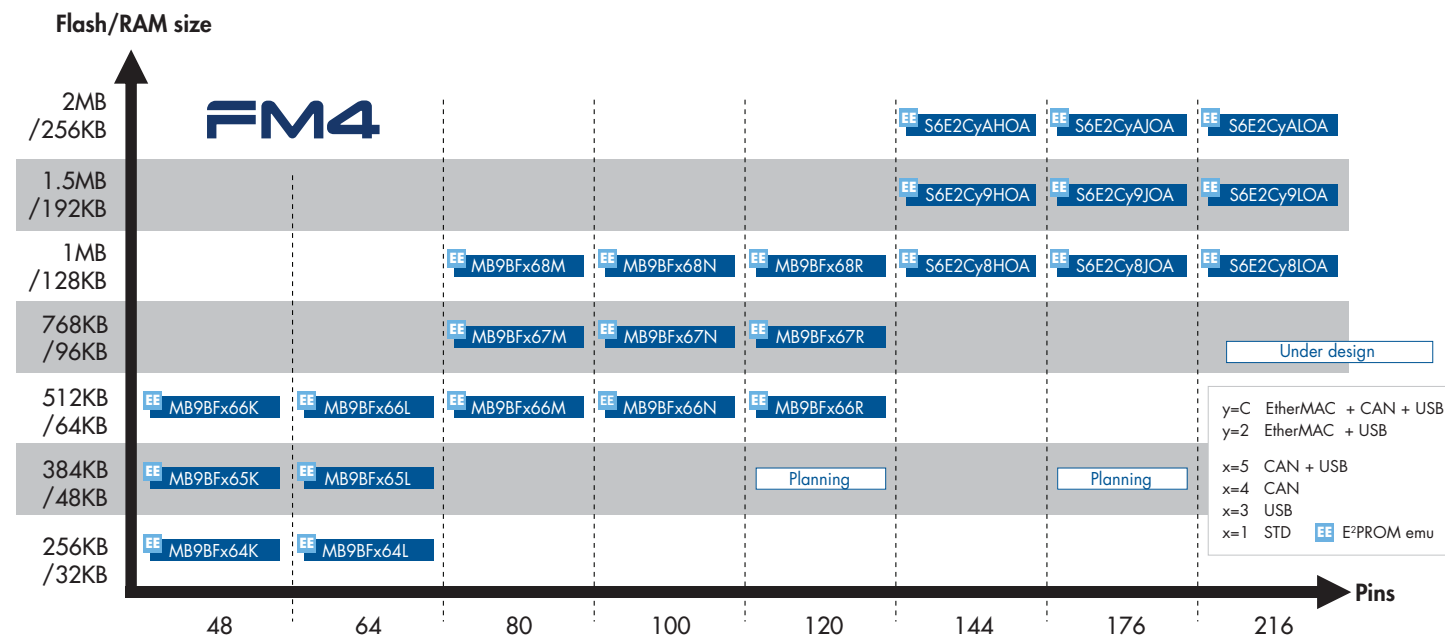

APPLICATIONS

- Inverter motor control
- Factory automation, PLCs
- Highly efficient white goods
- Medical
- Surveillance

NETWORKS

- Enriched communication function (SD I/F, Ethernet, CAN-FD, High speed serial I/F, HS SPI)
- Large size memory
- SDRAM I/F

KEY FEATURES

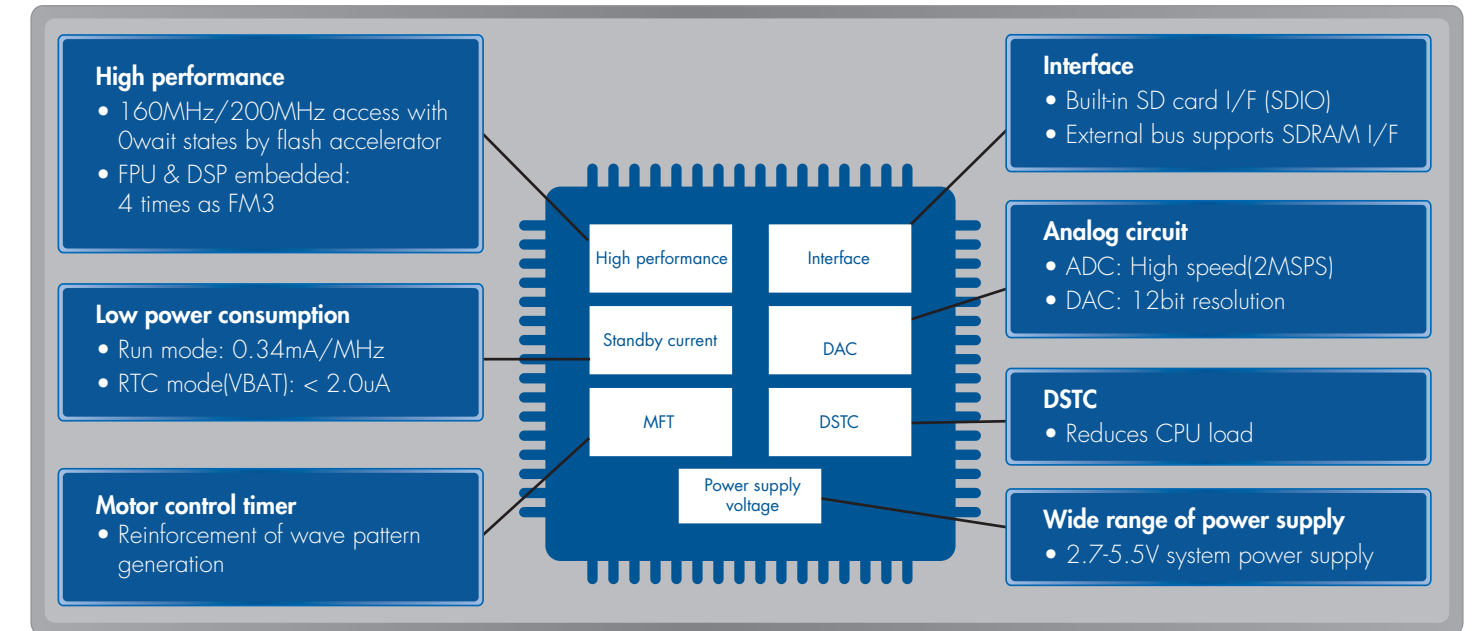

FM4 PACKAGE LINEUP

Pin	LQFP	QFP	BGA	QFN
216	24x24mm/0.4mm	—	—	—
192	—	—	12x12mm/0.8mm	—
176	24x24mm/0.5mm	—	—	—
144	20x20mm/0.5mm	—	7x7mm/0.5mm	—
120	16x16mm/0.50mm	—	—	—
112	—	—	7x7mm/0.5mm	—
100	14x14mm/0.50mm	14x20mm/0.65m	—	—
80	14x14mm/0.65mm 12x12mm/0.50mm	—	—	—
64	12x12mm/0.65mm 10x10mm/0.50mm	—	—	9x9mm/0.50mm
48	7x7mm/0.50mm	—	—	9x9mm/0.50mm

S6E2CC

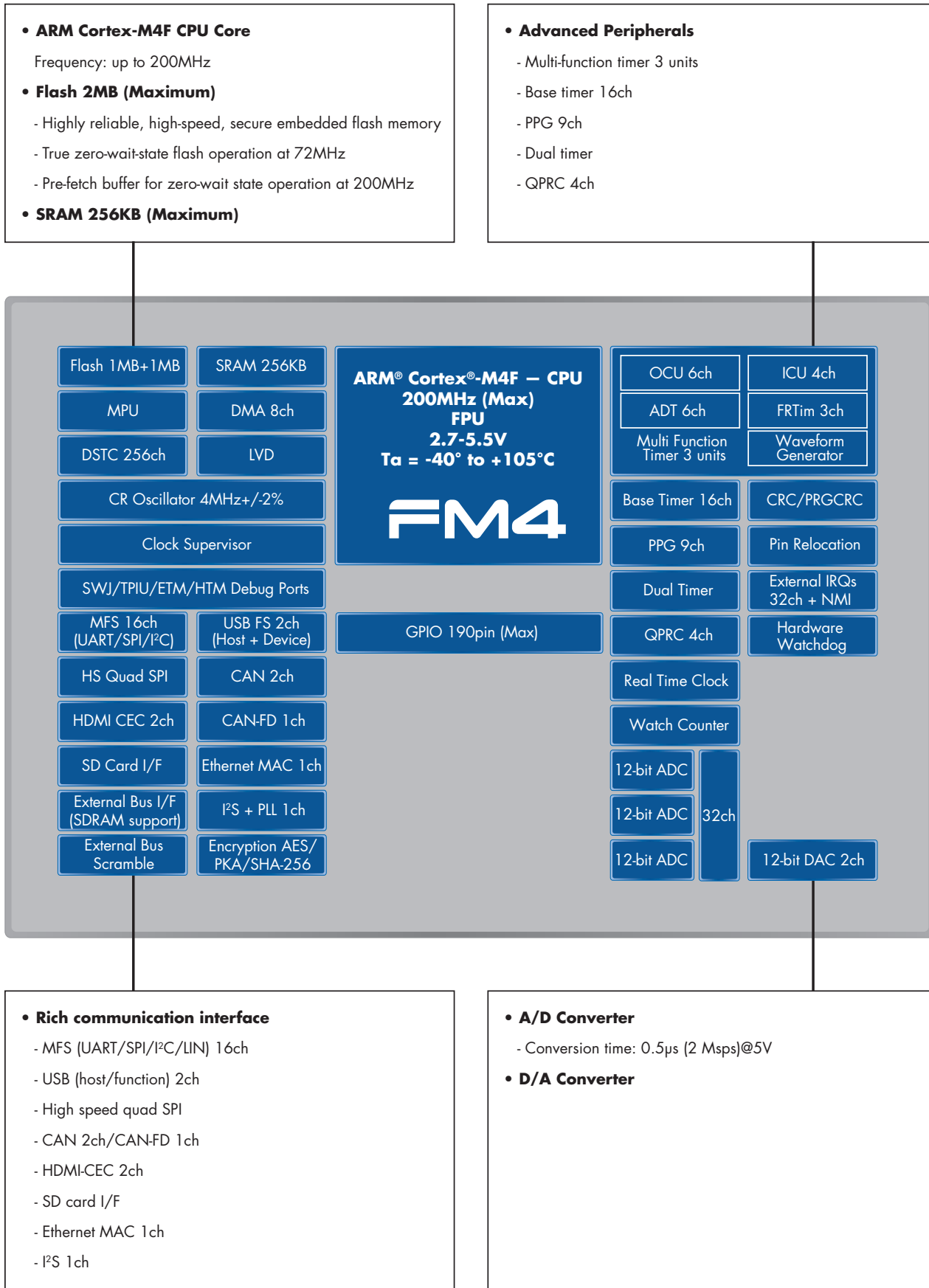

SYSTEM BLOCK DIAGRAM

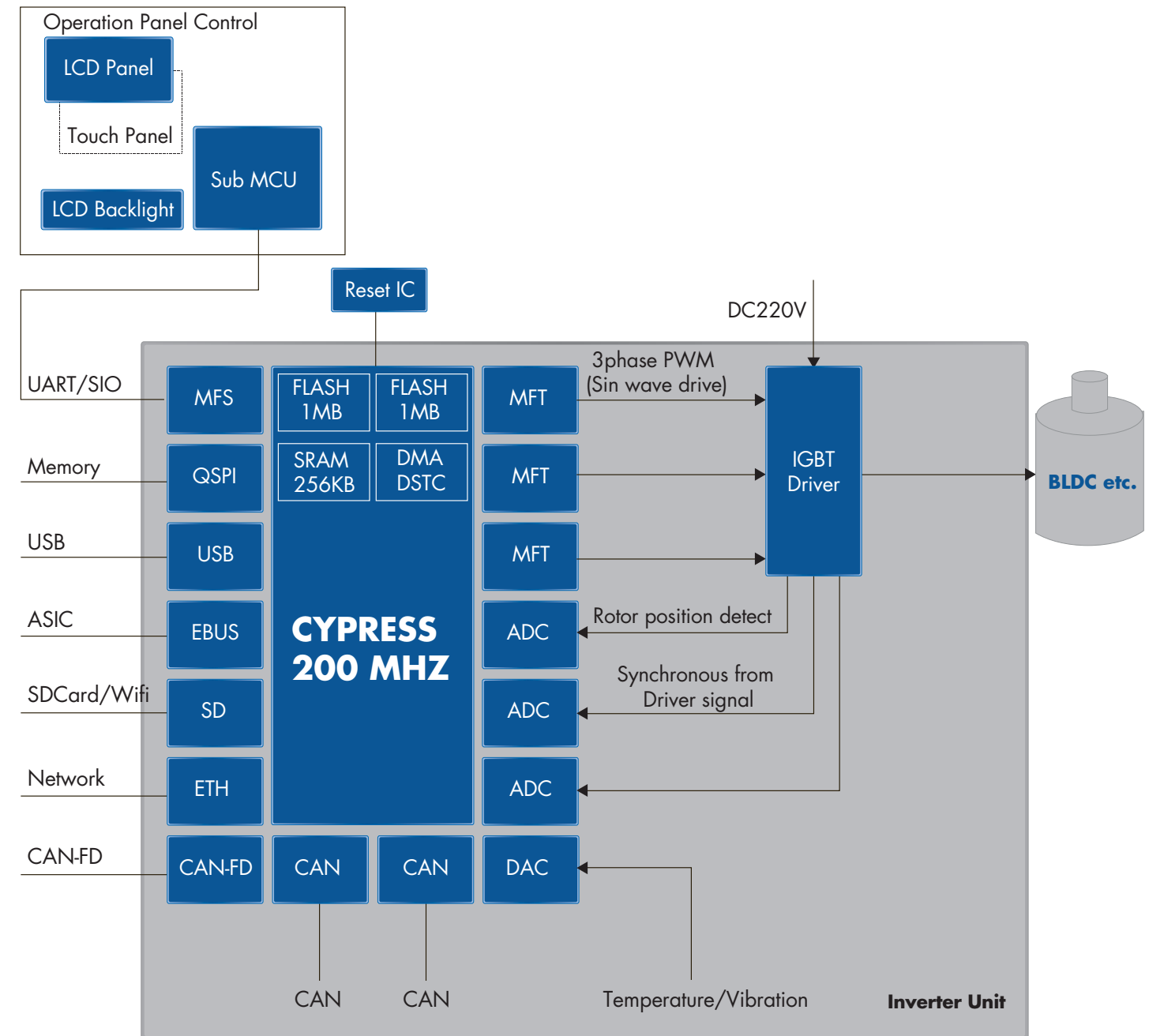

CYPRESS FM3 FAMILY

The FM3 family of 32-bit general-purpose MCUs is based on the ARM Cortex-M3 CPU, providing a scalable platform for many consumer and industrial applications. Popular applications range from motor control, factory automation, white goods and power tools to medical devices, major home appliances, digital consumer devices and office automation equipment.

The MCUs include a host of peripheral features, including multiple motor-control timers, high-speed ADCs, and a variety of communication interfaces. The wide operating voltage range (1.8V to 5.5V) improves the signal-to-noise ratio, resulting in a robust design that is unique among Cortex-M3 microcontroller families. Available packages range from 32 pin to 176 pin with flash memory densities ranging from 64KB to 1.5MB.

The FM3 family, which features a maximum operating frequency of 20-144 MHz, is split into four groups: high-performance, basic, low-power and ultra-low-leakage. All products are based on the same architecture for software compatibility, use the same peripherals and are pin compatible in most cases. The main differences between the groups are the CPU operating frequency and supply voltage.

SUB-FAMILIES

HIGH PERFORMANCE	BASIC	LOW POWER	ULTRA LOW LEAKAGE
<ul style="list-style-type: none"> Up to 144MHz 2.7V-5.5V Up to 1MB flash Up to 128KB RAM USB, device and host CAN Ethernet Motor control 	<ul style="list-style-type: none"> Up to 72MHz 2.7V-5.5V Up to 1.5MB flash Up to 192KB RAM USB, device and host CAN Motor control Optimized cost 	<ul style="list-style-type: none"> 40MHz 1.65V-3.6V Separated power domains LCD USB, device and host 	<ul style="list-style-type: none"> 20MHz 1.8V-5.5V Low stop mode current consumption LCD, CAN Standard set of peripherals

APPLICATIONS

- Factory automation
- Building automation
- Motor control
- Home appliances
- Power tools
- Handheld devices
- Medical

KEY FEATURES

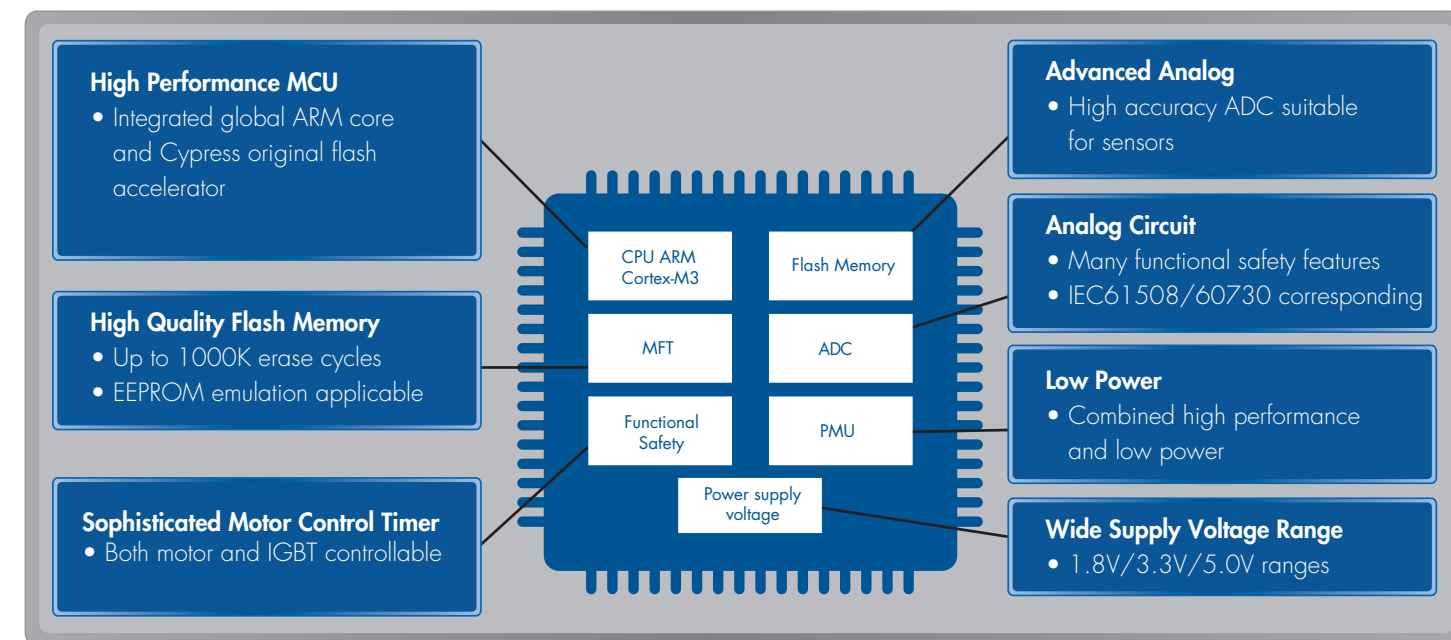

FM4 PACKAGE LINEUP

Pin	LQFP	QFP	BGA	QFN
192	—	—	12x12mm/0.8mm	—
176	24x24mm/0.5mm	—	—	—
144	20x20mm/0.5mm	—	—	—
120	16x16mm/0.50mm	—	—	—
112	—	—	10x10mm/0.8mm	—
100	14x14mm/0.50mm	14x20mm/0.65mm	—	—
96	—	—	6x6mm/0.5m	—
80	14x14mm/0.65mm 12x12mm/0.50mm	—	—	—
64	12x12mm/0.65mm 10x10mm/0.50mm	—	—	9x9mm/0.50mm
52	10x10mm/0.65mm	—	—	—
48	7x7mm/0.50mm	—	—	7x7mm/0.50mm
32	7x7mm/0.50mm	—	—	5x5mm/0.50mm

Note: Left value is body size, right value is pin pitch.

FM3 HIGH-PERFORMANCE GROUP

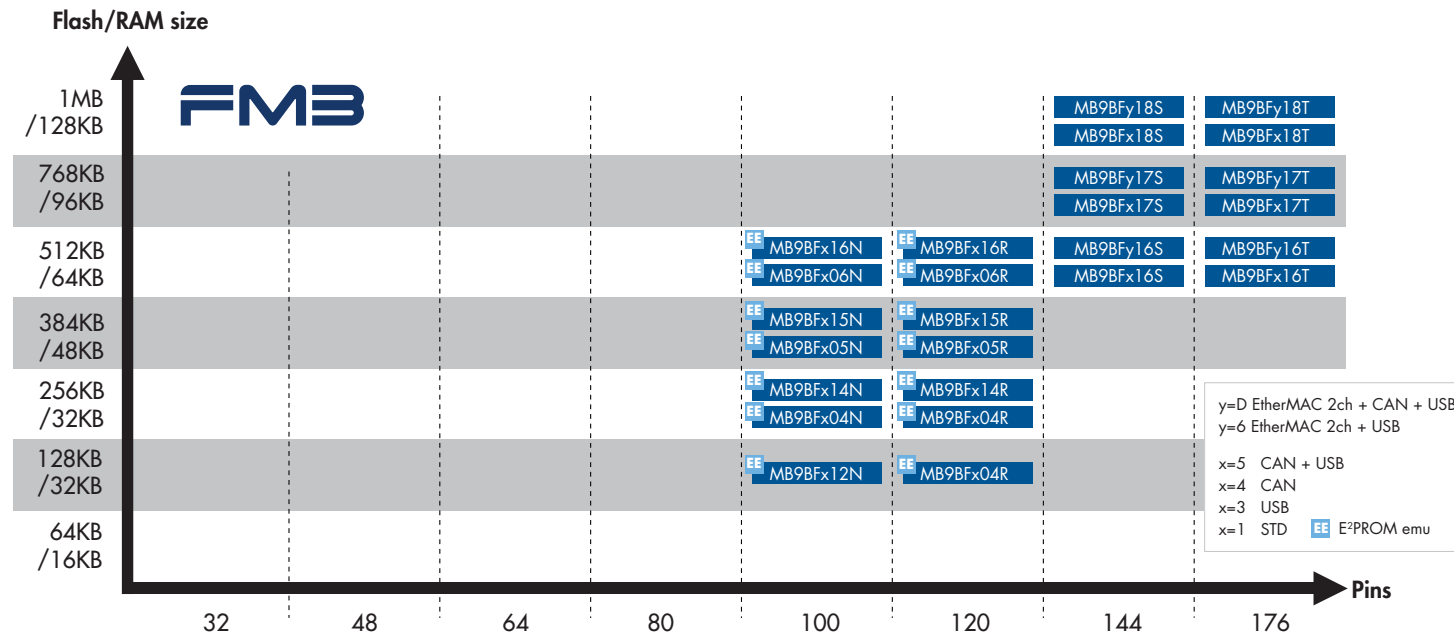

MB9BD10S/T

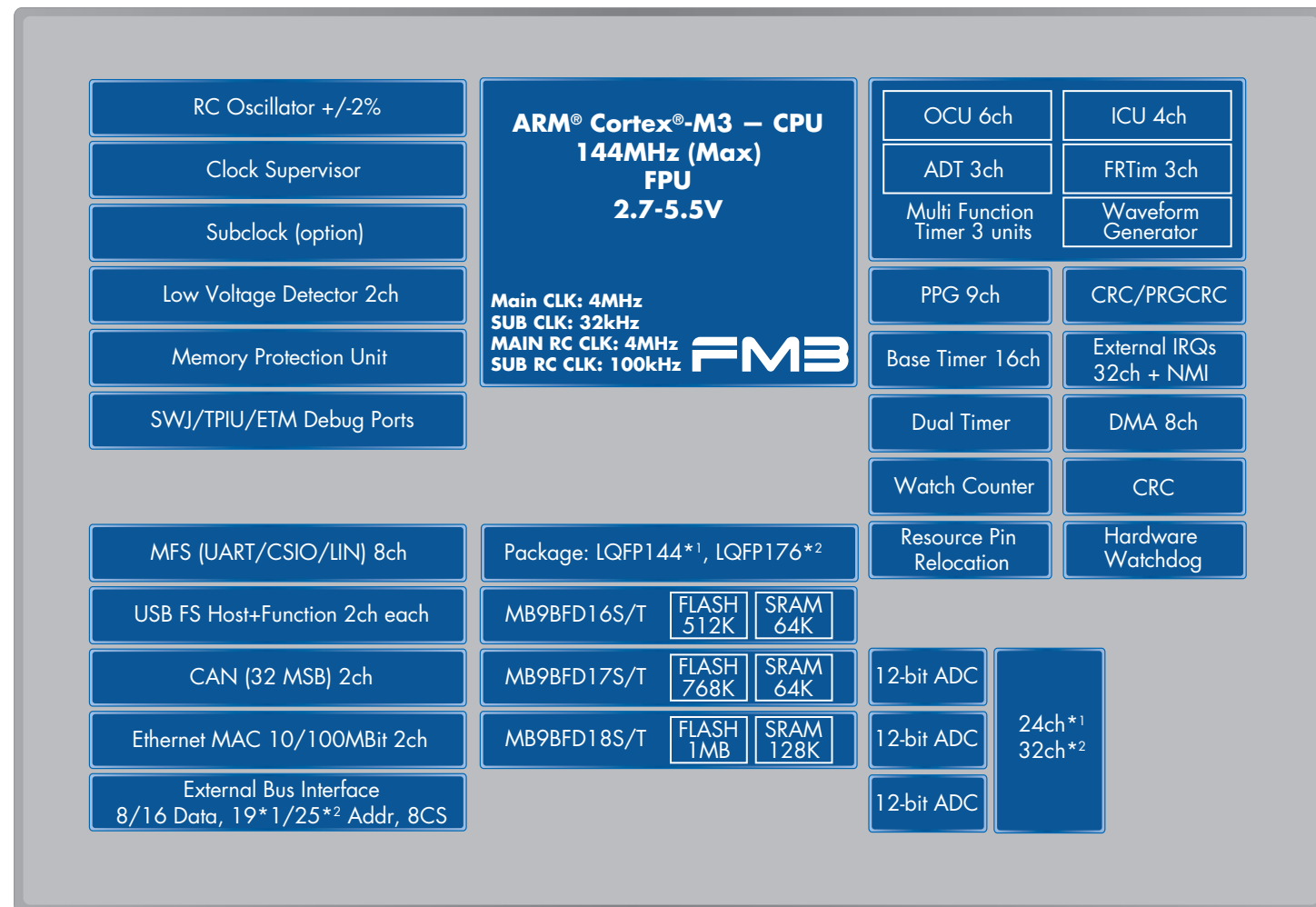

BASIC GROUP

- Frequency: up to 72MHz
- Operating voltage: 2.7-5.5V
- Flash: 64KB-1.5MB
- Up to 192KB RAM
- 32-176 pin packages
- IP: CAN, USB2.0, motor control

APPLICATIONS

- Household appliances
- Motor control
- Office automation
- Power tools
- Factory automation sensors

FM3 BASIC GROUP

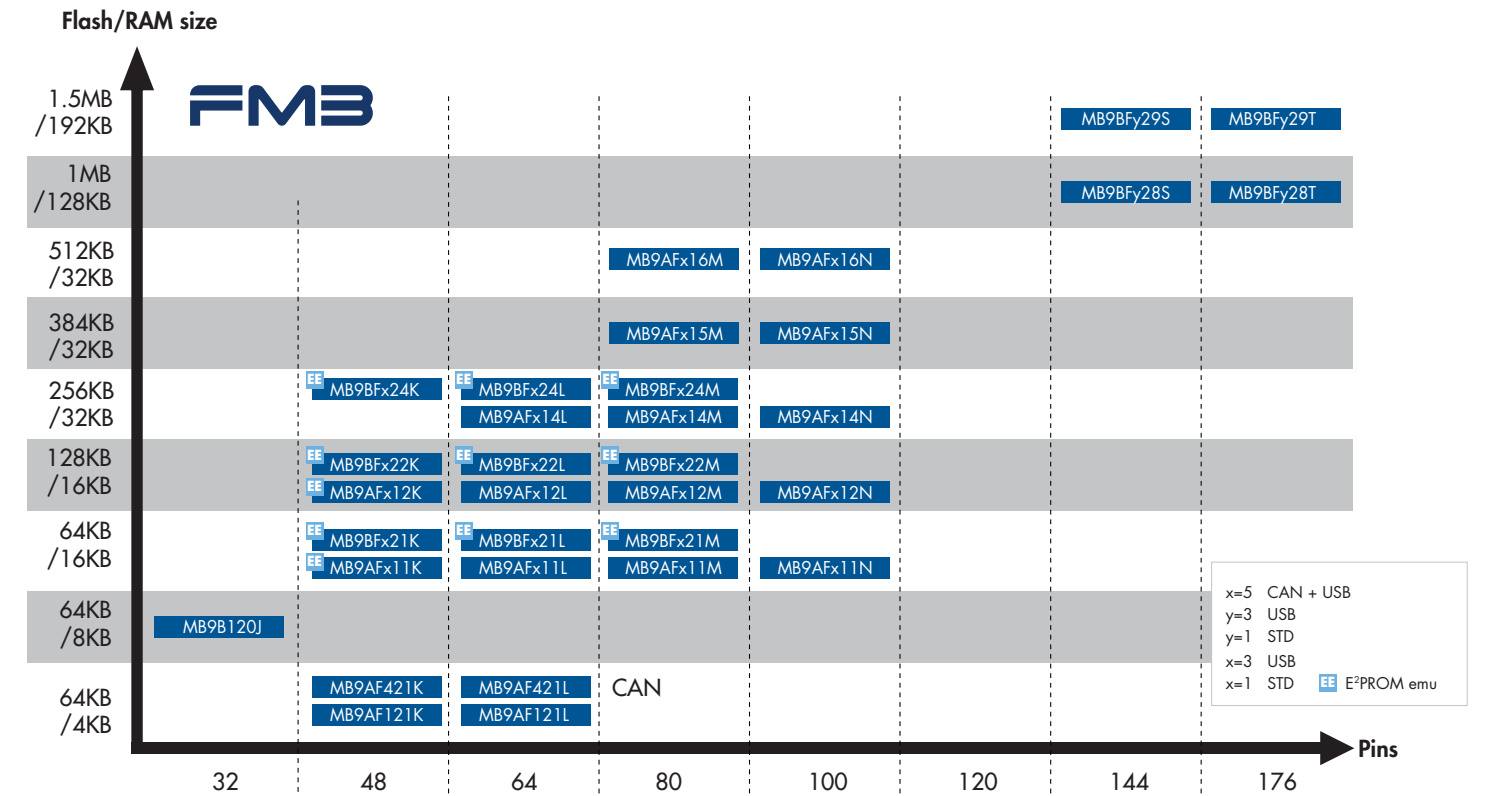

MB9A310N

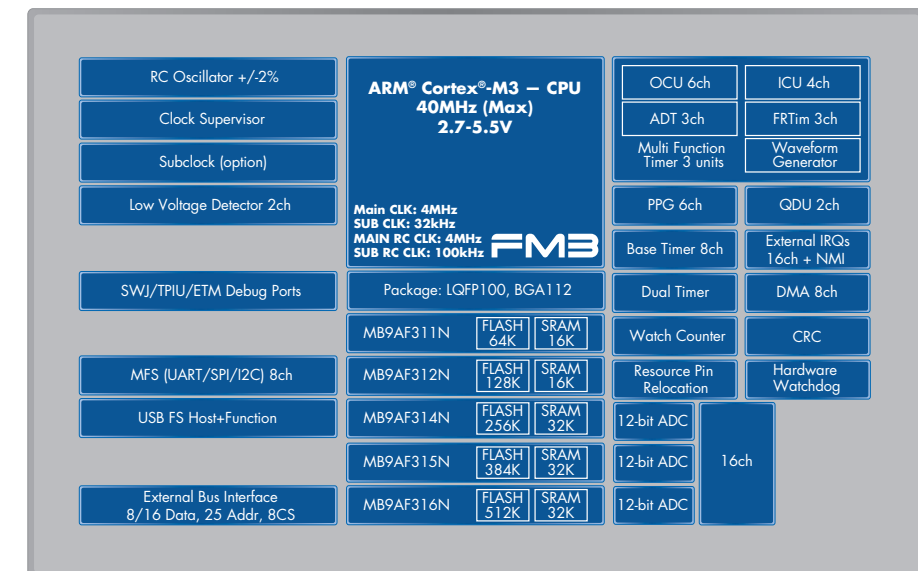

MB9A310K

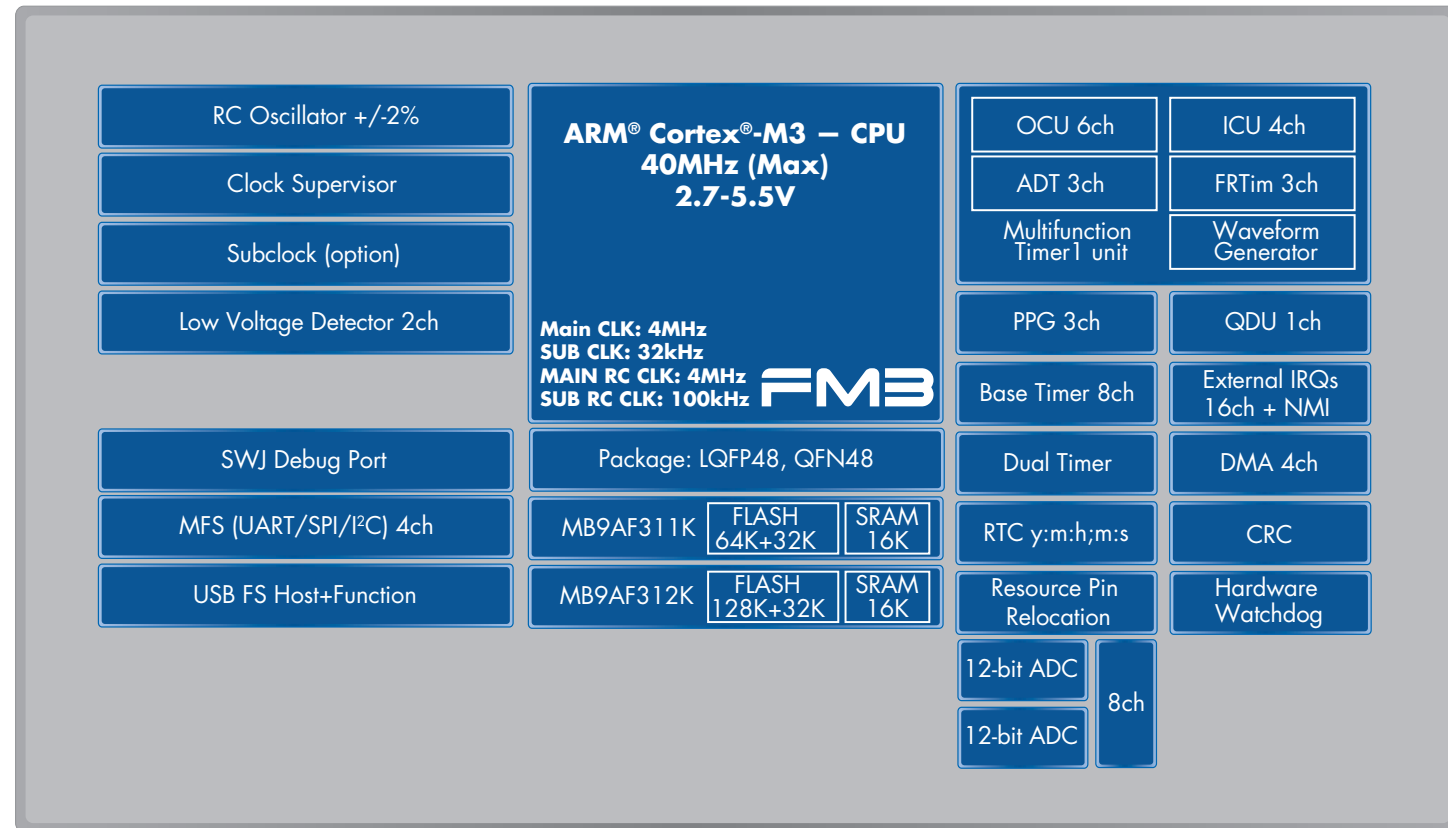

MB9B520K/L/M

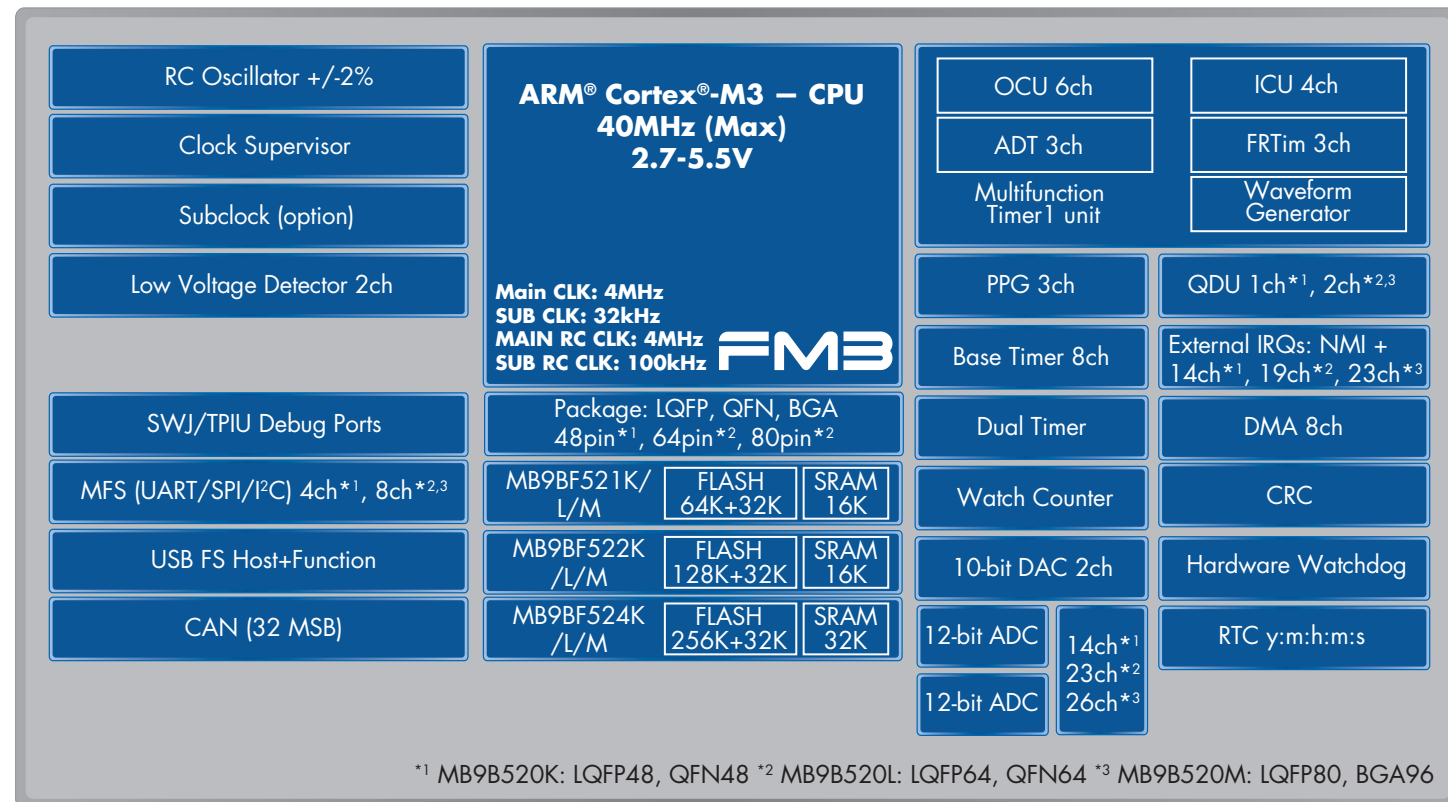

*1 MB9B520K: LQFP48, QFN48 *2 MB9B520L: LQFP64, QFN64 *3 MB9B520M: LQFP80, BGA96

MB9A420K/L

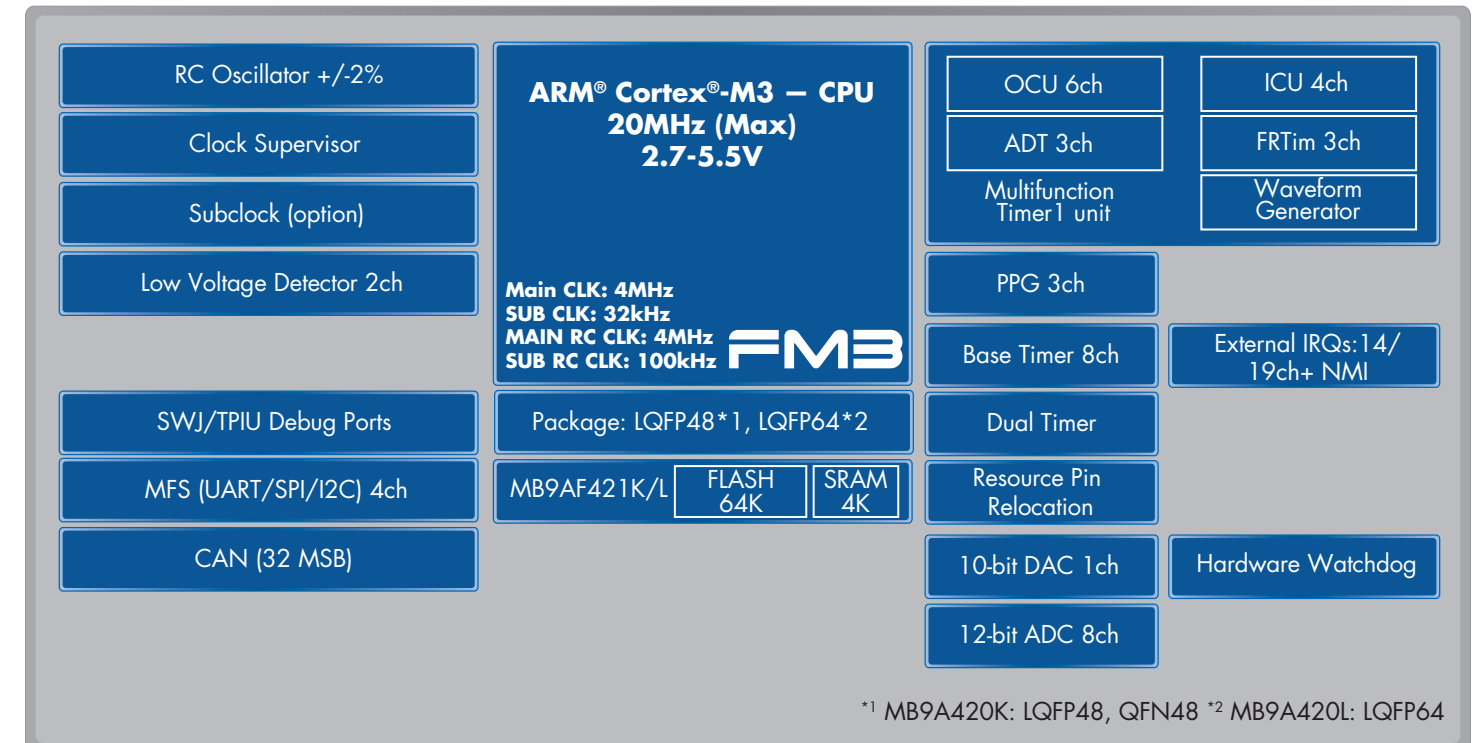

*1 MB9A420K: LQFP48, QFN48 *2 MB9A420L: LQFP64

LOW-POWER GROUP

- Frequency: 40MHz
- Operating voltage: 1.65-3.6V
- Separated power domains
- Low-power current: 200µA/MHZ (typical)
- USB2.0, LCD, HDMI-CEC

APPLICATIONS

- Handheld devices
- Metering
- Medical devices
- Battery-powered applications

FM3 LOW-POWER GROUP

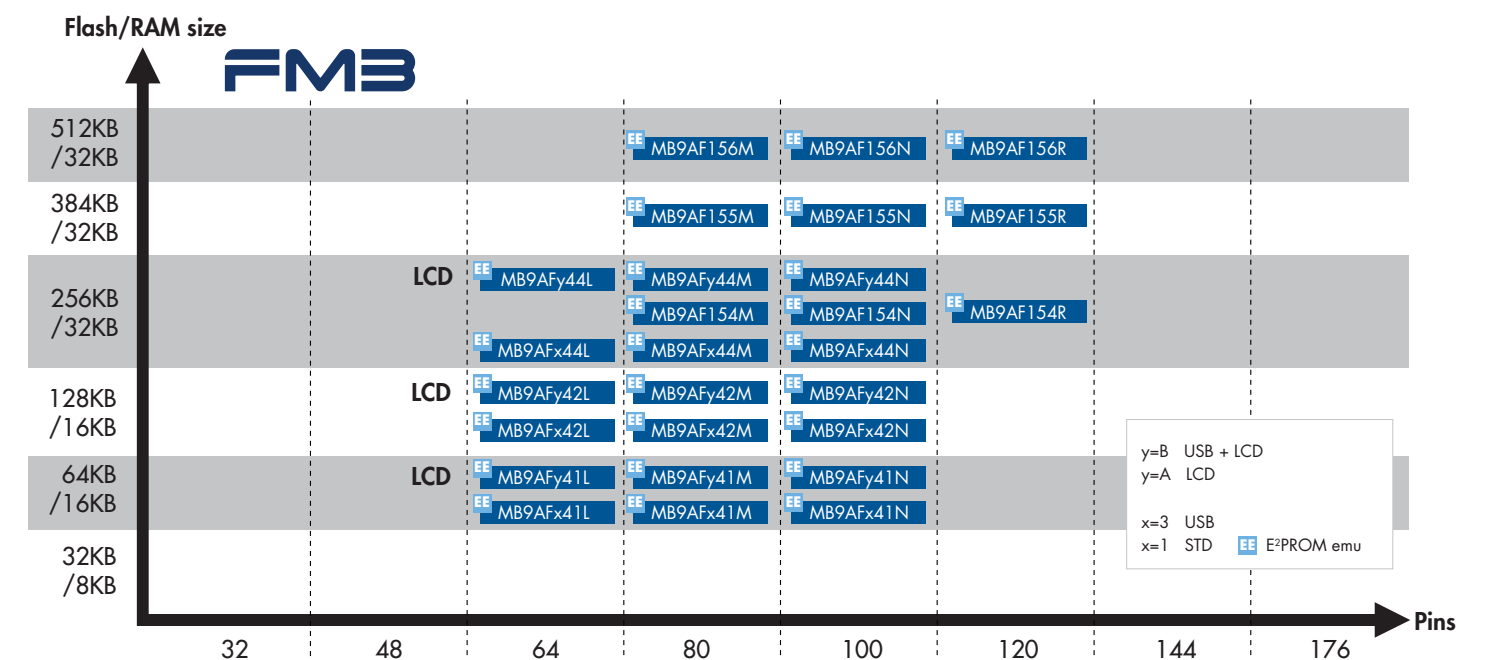

MB9AB40M/N

RC Oscillator +/-2%	ARM® Cortex®-M3 – CPU 40MHz (Max) 1.65-3.6V Main CLK: 4MHz SUB CLK: 32kHz MAIN RC CLK: 4MHz SUB RC CLK: 100kHz FMB	Dual Timer	External IRQs 11ch*1/16ch*2 + NMI
Clock Supervisor		Base Timer 8ch	DMA 8ch
Subclock (option)		RTC y:m:h:m:s	Hardware Watchdog
Low Voltage Detector 2ch		Resource Pin Relocation	CRC
SWJ/TPIU Debug Ports*1 SWJ/TPIU/ETM Debug Ports*2	Package: LQFP80*1, LQFP100*2, BGA112*2	LCDC (33seg x 8com)*1 (40seg x 8com)*2	
MFS (UART/SPI/I ² C) 8ch	MB9AFB41 M/N FLASH 64K+32K SRAM 16K	12-bit ADC	17ch*1 24ch*2
USB FS Host+Function	MB9AFB42 M/N FLASH 128K+32K SRAM 16K	12-bit ADC	
HDMI-CEC 2ch	MB9AFB44 M/N FLASH 256K+32K SRAM 32K		

*1 MB9AB40M: LQFP80 *2 MB9AB40N: LQFP100, BGA112

MB9A140L

RC Oscillator +/-2%	ARM® Cortex®-M3 – CPU 40MHz (Max) 1.65-3.6V Main CLK: 4MHz SUB CLK: 32kHz MAIN RC CLK: 4MHz SUB RC CLK: 100kHz FMB	Dual Timer	External IRQs 7ch + NMI
Clock Supervisor		Base Timer 8ch	DMA 8ch
Subclock (option)		RTC y:m:h:m:s	Hardware Watchdog
Low Voltage Detector 2ch		Resource Pin Relocation	CRC
SWJ Debug Ports	Package: LQFP64	12ch	
MFS (UART/SPI/I ² C) 8ch	MB9AF141L FLASH 64K+32K SRAM 16K	12-bit ADC	
HDMI-CEC 2ch	MB9AF142L FLASH 128K+32K SRAM 16K	12-bit ADC	
	MB9AF144L FLASH 256K+32K SRAM 32K		

ULTRA-LOW-LEAKAGE GROUP

- Frequency: 20MHz
- Operating voltage: 1.8-5.5V
- Low leakage current, ~ 0.4µA (at DS-Stop mode)
- Low-power-consumption mode
- Various IP: LCD, HDMI-CEC
- Standard set of peripherals
- Optimized low-leakage process technology

APPLICATIONS

- Metering
- Mobile devices
- Handheld devices

FM3 ULTRA-LOW-LEAKAGE GROUP

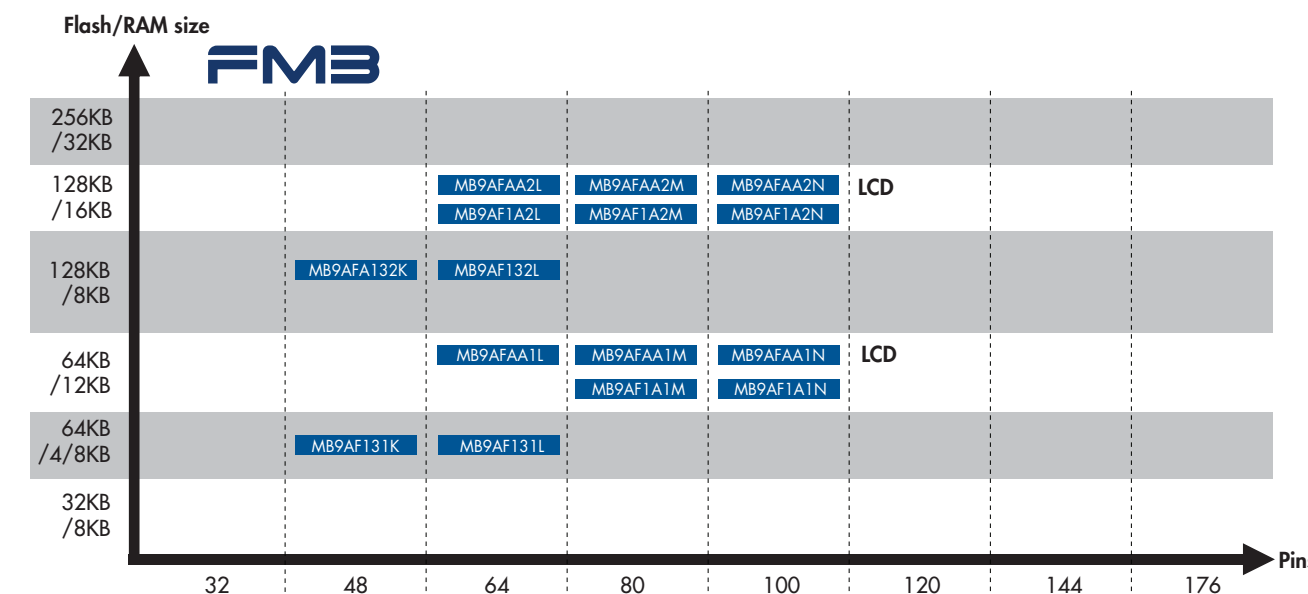

MB9AA30M/N

RC Oscillator +/-2%	ARM® Cortex®-M3 – CPU 20MHz (Max) 1.8-5.5V Main CLK: 4MHz SUB CLK: 32kHz MAIN RC CLK: 4MHz SUB RC CLK: 100kHz FMB	OCU 6ch	ICU 4ch
Clock Supervisor		ADT 3ch	FRTim 3ch
Subclock (option)		Multifunction Timer 1 unit	Waveform Generator
Low Voltage Detector 2ch		PPG 3ch	
SWJ/TPIU Debug Ports	Package: LQFP80*1, LQFP100*2, BGA112*2	Base Timer 8ch	External IRQs: 11ch*1 / 16ch*2 + NMI
MFS (UART/SPI/I ² C) 8ch	MB9AFA31 M/N FLASH 64K+32K SRAM 16K	RTC y:m:h:m:s	
	MB9AFA32 M/N FLASH 128K+32K SRAM 16K	Resource Pin Relocation	Hardware Watchdog
HDMI-CEC 2ch		LCDC (28seg x 8com or 32seg x 4com)*1 (40seg x 8com or 44seg x 4com)*2	
		10-bit DAC 2ch	
		12-bit ADC 12ch*1/16ch*2	

*1 MB9AA30M: LQFP80 *2 MB9AA30N: LQFP100, BGA112

CYPRESS FM0+ FAMILY

The FM0+ family, which is based on the ARM Cortex-M0+ core, is designed for industrial and cost-sensitive applications with low power requirements such as white goods, sensors, meters, HMI systems and power tools.

The family, which operates at 40MHz, has a run-mode current of 70µA/MHz and an RTC mode current of 0.7µA. The FM0+ family can be easily embedded into systems adopting Cypress's 8-, 16- or 32-bit MCUs, accelerating product development and reducing development costs. The FM0+ family includes two groups for ultra-low-power and cost-effective applications.

ULTRA-LOW-POWER GROUP

- Operating voltage: 1.65-3.6V
- Frequency: 40MHz
- Low power consumption
- EEPROM emulation
- Analog peripherals

ENTRY-LEVEL GROUP

- Operating voltage: 2.7-5.5V
- Frequency: 40MHz
- Flash: 56KB to 88KB
- 6KB RAM
- Cost efficient

S6E1A1

RC Oscillator +/-2%

Clock Supervisor

Subclock (option)

Low Voltage Detector 2ch

SW Debug Port

MFS (UART/SPI/I²C) 3ch

ARM® Cortex®-M3 – CPU
40MHz (Max)
2.7-5.5V

Main CLK: 4MHz
 SUB CLK: 32kHz
 MAIN RC CLK: 4MHz
 SUB RC CLK: 100kHz

FM0+_{ZERO}

Package: LQFP, QFN
 32pin, 48pin

S6E1A11B/C FLASH 56KB SRAM 6K

S6E1A12B/C FLASH 88KB SRAM 6K

OCU 6ch

ADT 3ch

Multifunction Timer1 unit

PPG 3ch

Base Timer 8ch

Dual Timer

Watch Counter

Resource Pin Relocation

12-bit ADC 5ch*², 8ch*¹

ICU 4ch

FRTim 3ch

Waveform Generator

QDU 1ch

External IRQs: NMI + 8ch

DMA 8ch

Hardware Watchdog

RTC y:m:h:m:s

*¹ S6E1A1xB0A: LQFP48, QFN48 *² S6E1A1xCOA: LQFP32, QFN32

FM0+ LOW POWER PRODUCT LINEUP

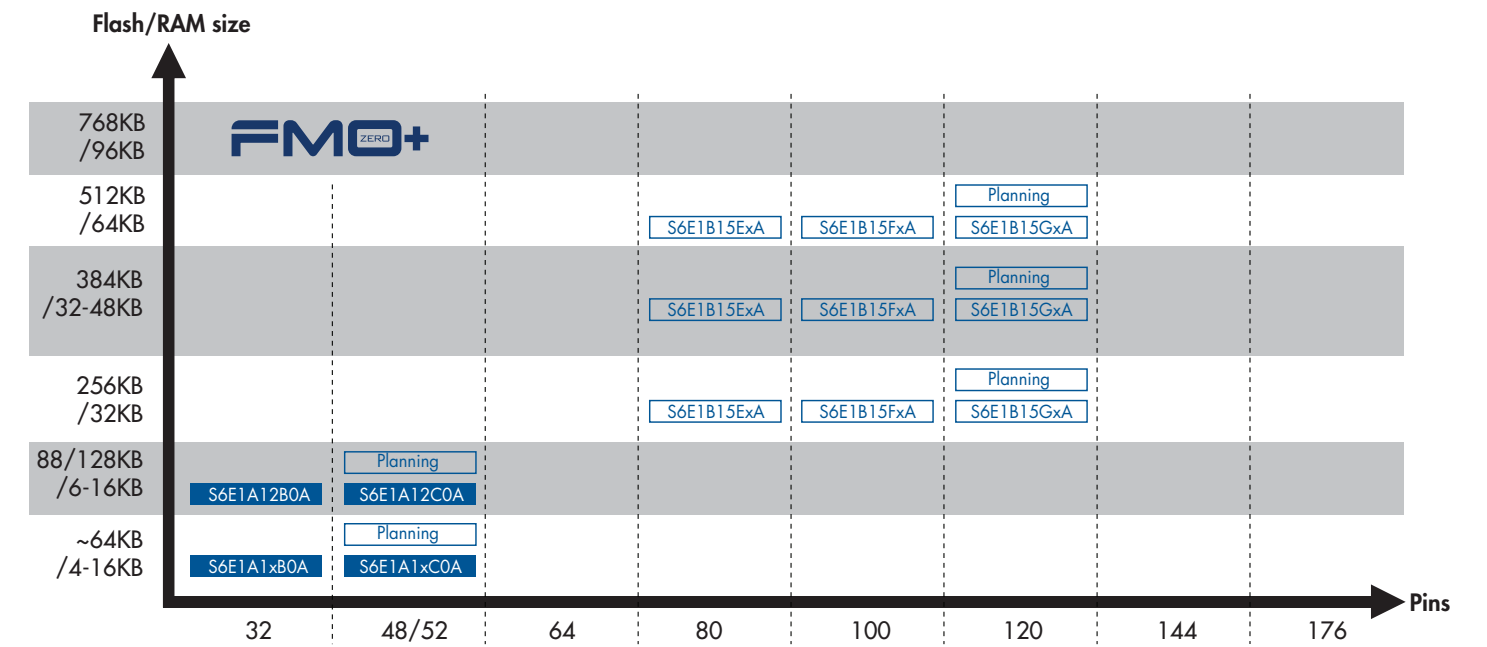

FM0+ PACKAGE LINEUP

Pin	LQFP	QFP	BGA	QFN
192	—	—	—	—
176	—	—	—	—
144	—	—	—	—
120	16x16mm/0.50mm	—	—	—
112	—	—	10x10mm/0.8mm	—
100	14x14mm/0.50mm	14x20mm/0.65mm	—	—
96	—	—	6x6mm/0.5m	—
80	14x14mm/0.65mm 12x12mm/0.50mm	—	—	—
64	12x12mm/0.65mm	—	—	—
52	10x10mm/0.65mm	—	—	—
48	7x7mm/0.50mm	—	—	7x7mm/0.50mm
32	7x7mm/0.80mm	—	—	5x5mm/0.50mm

Note: Left value is body size, right value is pin pitch.

FM0+ PACKAGE LINEUP

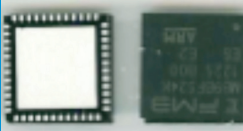
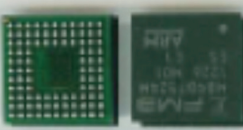
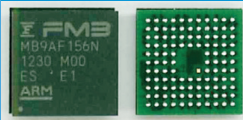
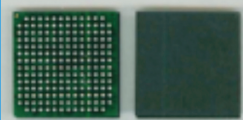
Part Number Package Code	Functional Pins	Package	Dimensions in mm (pitch)	Package Code	Photo
JPMC	32	LQFP	7x7 (0.8)	FPT-32P-M30	
JWQN	32	QFN	5x5 (0.5)	LCC-32P-M19	
KPMC	48	LQFP	7x7 (0.5)	FPT-48P-M49	
KQN	48	QFN	7x7 (0.5)	LCC-48P-M73	
LPMC	64	LQFP	12x12 (0.65)	FPT-64P-M39	
LPMC1	64	LQFP	10x10 (0.5)	FPT-64P-M38	
LQN	64	QFN	9x9 (0.5)	LCC-64P-M24	
MPMC	80	LQFP	12x12 (0.5)	FPT-80P-M37	
MPMC1	80	LQFP	14x14 (0.65)	FPT-80P-M40	
MBGL	80 (96 balls)	BGA	6x6 (0.5)	BGA-96P-M07	
NPF	100	QFP	14x20 (0.65)	FPT100P-M36	
NPMC	100	LQFP	14x14 (0.5)	FPT-100P-M23	
NBGL	100 (112 balls)	BGA	10x10 (0.8)	BGA-112P-M04	
NBGL	100 (112 balls)	BGA	7x7 (0.5)	BGA-112P-M05	
RBGL	120 (144 balls)	BGA	7x7 (0.5)	BGA-114P-M09	
RPMC	120	LQFP	16x16 (0.5)	FPT-120P-M37	
SPMC	144	LQFP	20x20 (0.5)	FPT-144P-M08	
TPMC	176	LQFP	24x24 (0.5)	FPT-176P-M07	
TBGL	176 (192 balls)	BGA	12x12 (0.8)	BGA-192P-M06	

DEVELOPMENT TOOLS

Cypress's microcontroller families are supported by development tools, including integrated development environments (IDEs), middleware and evaluation boards that have a proven track record with partner vendors.



<http://www.iar.com>

IAR SYSTEMS offers comprehensive tool solutions including compiler, debugger and starter kit.

IDE/Compiler Debugger OS Middleware Simulator



www.atollic.com

Atollic offers development tools based on GNU and Eclipse IDE.

IDE/Compiler Debugger OS Middleware Simulator



www.keil.com/arm/mdk.asp

ARM offers comprehensive tools and software solutions for embedded development within uVision IDE KEIL.

IDE/Compiler Debugger OS Middleware Simulator



www.coocox.org

CooCox offers a highly-integrated development environment for ARM Cortex M4, M3, M0 and M0+ based microcontrollers, which includes IDE, flash programmer and realtime OS.

IDE/Compiler Debugger OS Middleware Flash Programmer



www.computex.co.jp/eg

Computex offers JTAG adapter, PALMiCE3 and flash programmer, FP-10.

IDE/Compiler Debugger Flash Programmer



www.conitec.com

From small sized programmers for software development to mass programming solution, CONITEC offers comprehensive flash programming solutions.

Flash Programmer



www.cmx.com

CMX offers RTOS for ARM Cortex M3 and M4 based microcontrollers.

OS



www.eforce.co.jp

eForce offers uLTRON based RTOS and TCP/IP stack for FM3.

OS Middleware



www.elnec.com

ELNEC offers single, multi and gang programmers.

Flash Programmer



www.emprog.com

Emprog ThunderBench offers a complete development tool solution within an embedded Eclipse IDE.

IDE/Compiler Debugger OS Middleware Flash Programmer



www.esol.com

eSOL offers embedded system software and development tools with core technologies in real-time operating systems.

IDE/Compiler Debugger OS Middleware



www.rtos.com

Express Logic offers RTOS, middleware and tools designed to ease development of embedded real-time applications.

OS Middleware



www.falcon-denshi.co.jp/en

Falcon Electronics offers flash programmers and IC programming service.

Flash Programmer

DEVELOPMENT TOOLS

Flash Support Group

www.j-fsg.co.jp/en/ Flash Support Group offers single programmers and on-board programmers.

Flash Programmer



GAIO Technology offers software testing tool and simulator products.

Simulator



From compiler and debugging environment to realtime OS, Green Hills offers total comprehensive tool solutions.

IDE/Compiler

Debugger

OS

Middleware

Simulator



GRAPE SYSTEMS offers realtime OS, USB and SD card middleware.

OS

Middleware



DEVELOPMENT TOOLS
www.hitex.com

Hitex offers debugging environment and realtime OS and middleware products.

Debugger

OS

Middleware

Flash Programmer



www.isystem.com

iSystem offers complete software development and analysis solutions which are complemented by a unique software test tool (testIDEA), requiring no code instrumentation.

IDE/Compiler

Debugger

Simulator



Kyoto Microcomputer offers debugging environment, PARTNERJet.

IDE/Compiler

Debugger



www.mentor.com

Mentor Graphics offers GNU based integrated development environment, Sourcery CodeBench.

IDE/Compiler

Debugger

Simulator



www.micrium.com

Micrium offers realtime OS, USB and TCP/IP stacks.

OS

Middleware



www.minato.co.jp/en

MINATO ELECTRONICS offers single and gang flash programmers.

Flash Programmer



www.sys.ndk-m.com

NAITO DENSEI MACHIDA MFG offers flash programmers best suited to be burned on production line.

Flash Programmer



www.personal-media.co.jp

PERSONAL MEDIA offers embedded solutions related to T-Kernel and iT-Kernel.

OS

Middleware



www.rowebots.com

RoweBots offers tiny Linux.

OS



<http://www.rowley.co.uk>

Rowley offers an integrated development environment which includes GNU compiler collection, their own C library, editor, project manager, flash downloader and debugger. Rowley also offers a JTAG adapter and their own RTOS.

IDE/Compiler

Debugger

OS

Flash Programmer

Simulator

DEVELOPMENT TOOLS



SEGGER offers debugging tools, realtime OS and middleware.

Debugger

OS

Middleware

Flash Programmer

www.j-fsg.co.jp/en/



SEVENSTAX offers TCP/IP stack.

OS

Middleware

www.sevenstax.de/en/home



Sohwa & Sophia Technologies offers debugging tools and EJS-CATT.

www.ss-technologies.co.jp/en

IDE/Compiler

Debugger

OS

Middleware

Flash Programmer

Simulator



TASKING offers compiler, debugger, RTOS and TCP/IP middleware.

www.tasking.com

IDE/Compiler

Debugger

OS

Middleware



Techno Mathematical offers audio middleware.

www.tmath.co.jp/eng

OS

Middleware



Tsuzuki widely supports FM family products from debugging environment to engineering services.

tsuzuki.jp/products/list03.html

IDE/Compiler

Debugger



UC technology offers "µT-Kernel", the next generation RTOS of ITRON, and TCP/IP supporting FM Family.

ts.uctec.com/uctec/t-kernel/en/products/fm3_ewarm.php

OS

Middleware



Yokogawa Digital Computer offers debugging tools and flash programmers.

www2.yokogawa-digital.com/en/

Debugger

Flash Programmer



Wave Technology offers programmers for mass production
wavetechnology.co.jp/en/

Flash Programmer



XELTEK offers in-system, cluster, gang, parallel and automated programmers for various PICS, FPGAs, MCUs and high density eMMC NAND flash chips.

www.xeltek.com

Flash Programmer

SOFTWARE ENABLEMENT

A diverse range of software enablement components are available, including real-time operating systems, low-level peripheral libraries and protocol stacks. In many cases, the user can choose between commercial and free solutions.

CYPRESS LOW-LEVEL AND MIDDLEWARE COMPONENTS

- Peripheral, low-level library
- CMSIS compliant
- USB library
- Ethernet TCP/IP stack, software switch (IEC60730 – Class B, IEC61508 SIL2)
- EEPROM emulation library
- Motor control platform
- Capacitive touch library
- Virtual starter kit
- Pin and Code Wizard

OPERATING SYSTEMS

- FreeRTOS
- Micrium µC/OS-II
- Segger emboss
- Avix/RT

PARTNER MIDDLEWARE COMPONENTS

- USB library
- Ethernet TCP/IP stacks and applications layers
- CANopen protocol stacks

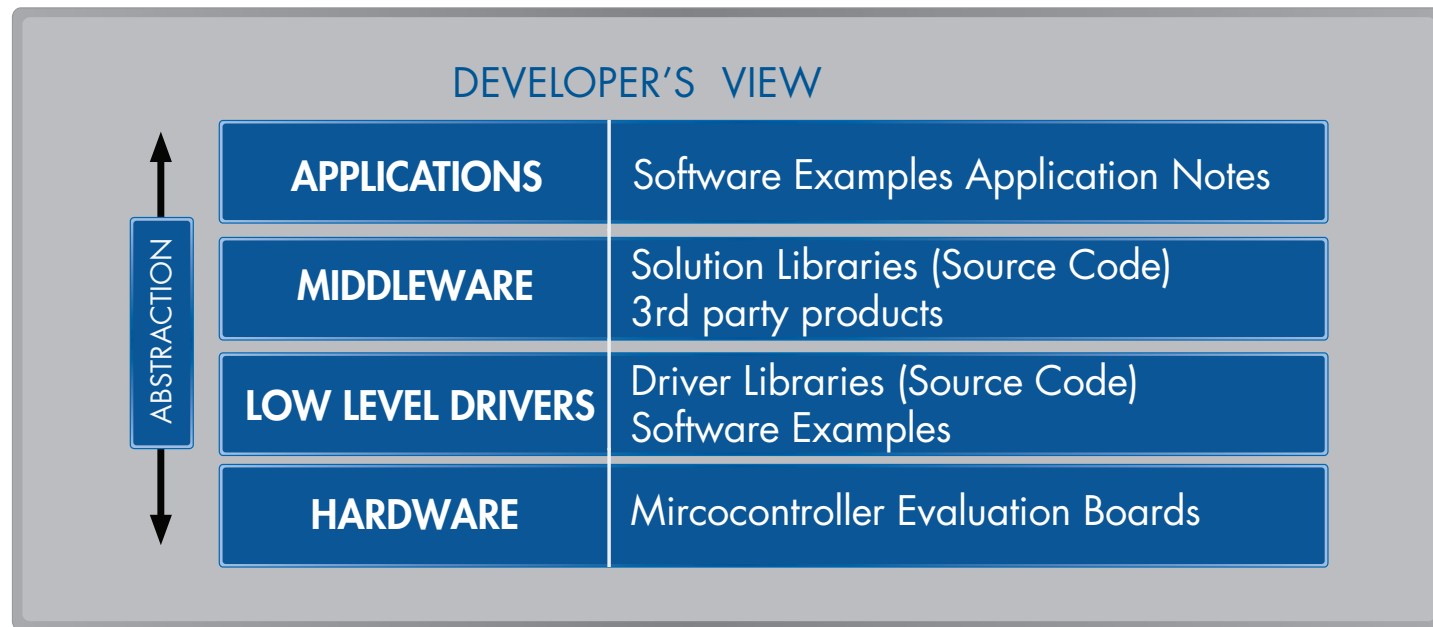

CYPRESS FM FAMILY MCU SIMULATOR

Cypress's FM family MCU simulator is a virtual starter kit for Cypress's FM family of MCUs. This tool provides a complete simulation environment allowing users to utilize a software development kit versus evaluation boards. Overall software development time is dramatically shortened due to the efficiency of the debugging and analysis ability of this virtual starter kit.

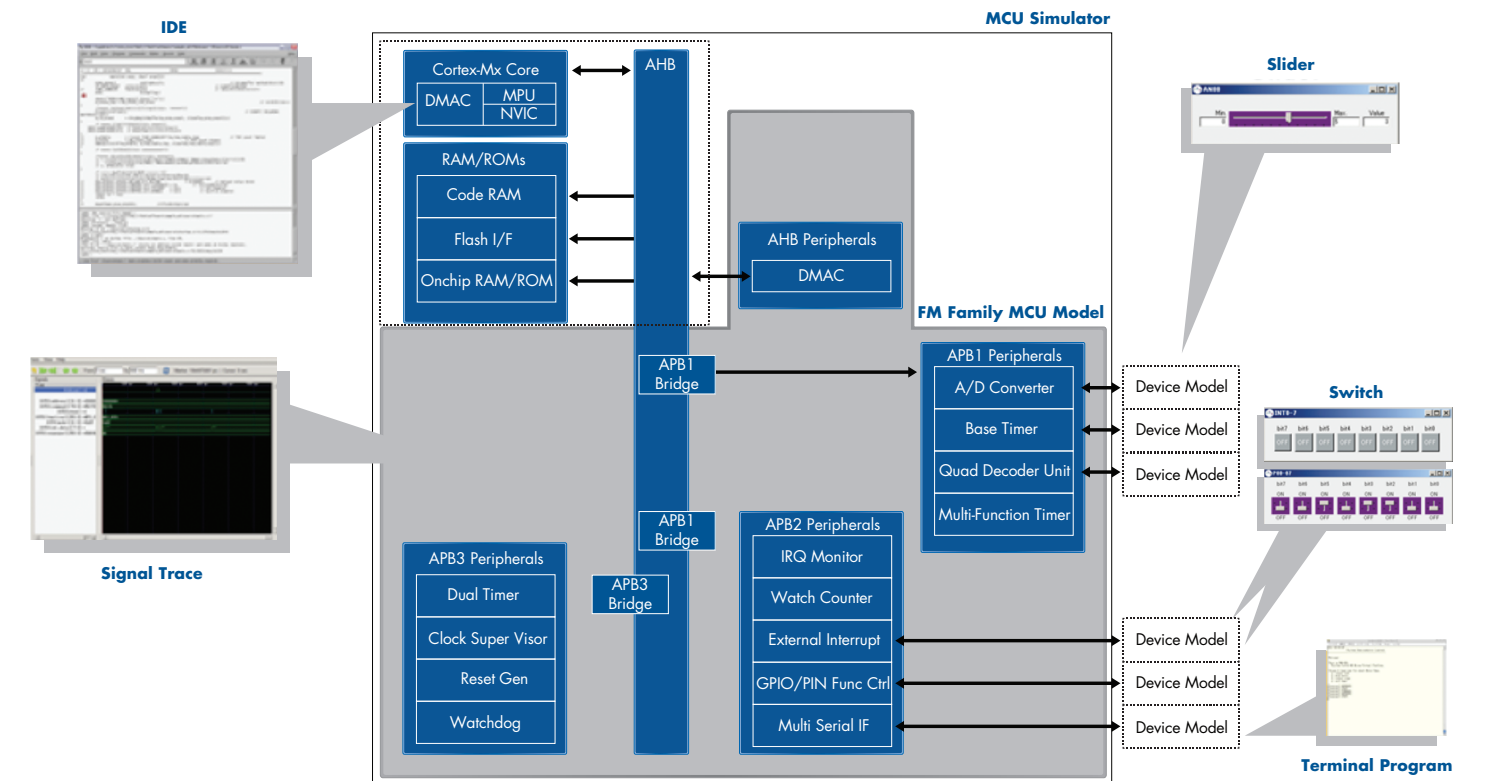

APPLICATIONS

Software Development

- Driver development
- Middleware development
- Application development

Software Sequence Evaluation

- Communication protocol with external devices
- Interrupt response sequence
- Task sequence

System Evaluation

- Peripheral behavior
- System behavior

<http://www.cypress.com/spansion-redirect>

PIN AND CODE WIZARD

This Windows-based tool is for the Cypress FM family of ARM Cortex-M microcontrollers to enable easy configuration of pin assignments for multiplexed options. It allows developers to graphically assign pin functions in an intuitive and simple manner that aids collision avoidance and generates register initialization code.

Automatic Pin Assignment

Assign the selected peripherals to pin automatically

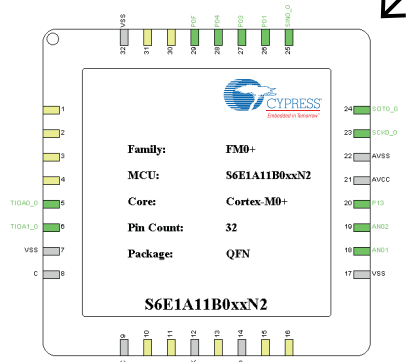
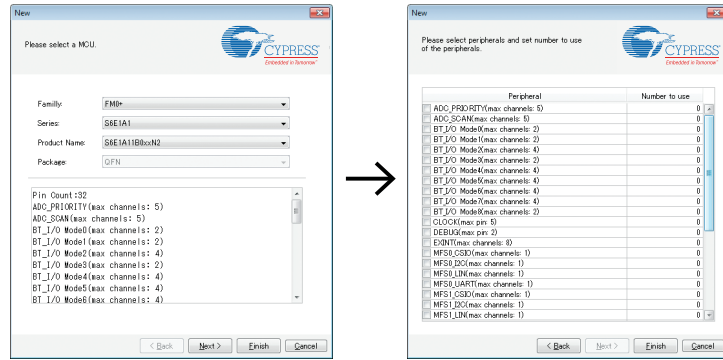

Edit Window

Customize while reviewing the pin assignment status and display the status of any conflicts

Pin	ADC_PRIORITY	BT_U0_Mode5	MFS0_CSIO	GPIO
1	TIOA1_1		SCK1_2	P3A
2	TIOA1_1		SOT1_2	P3B
3	TIOA2_1		SIN1_2	P3C
4	TIOA2_1			P3D
5	TIOA0_0			P3E
6	TIOA1_0			P3F
10				P46
11				P47
18	ADTO_1			PE0
15				PE2
16				PE3
18	AN01			P11
19	AN02			P12
20	AN03			P19
23	AN06	TIOA2_0	SCK0_0	P23
24	AN07		SOT0_0	P22
25			SIN0_0	P21
26				P03
27				P04
28				P0F
29				P0F
30				P01
31	TIOA2_2			P00

Project Output

Project output includes source code file with initialization code for user assigned pin functions

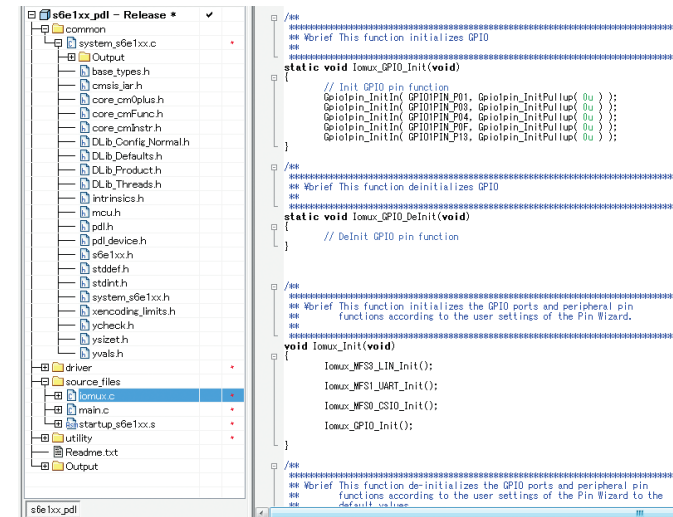

FEATURES

- Graphical user interface for assigning pin functions
- Generates register initialization source code for user assigned pin functions
- Automatic collision detection and reporting for error control
- Ability to do manual pin assignments and adjustments
- Generates source code to pre-build projects for supported IDEs

<http://www.cypress.com/documentation/software-and-drivers/pin-and-code-wizard-0>



EVALUATION BOARDS

Developers can select the right-sized solution from a wide range of MCU evaluation boards. In addition to the basic MCU motherboards, application-specific adapter boards are available. These boards come with sample software and libraries to guarantee an out-of-the-box experience. Some boards are available bundled with a JTAG adapter.

Tool	Features	Tool	Features
	Starter Kit with MB9BF516N MCU (100pin MCU) <ul style="list-style-type: none"> • All MCU pins accessible • CAN, USB Host+Func, RS232 • 2 x 7seg LEDs, buttons • 3V and 5V operation • Optionally available with J-Link JTAG adapter Extendable through pin headers (different extension boards available) 		Starter Kit with MB9BF524M/K MCU (80pin/48pin MCU) <ul style="list-style-type: none"> • All MCU pins accessible • USB Host+Func, RS232 • CAN • 2 x 7seg LEDs, buttons • 3V and 5V operation
	Starter Kit with MB9AF314L MCU(64pin MCU) <ul style="list-style-type: none"> • All MCU pins accessible • USB Host+Func, RS232 • 2 x 7seg LEDs, buttons • 3V and 5V operation • Optionally available with J-Link JTAG adapter 		Starter Kit with MB9AF312K MCU(48pin MCU) <ul style="list-style-type: none"> • All MCU pins accessible • USB Host • USB Device • JTAG debug Interface adapter included • Temp sensor, button, LED
	Starter Kit with MB9AF132L MCU(64pin MCU) <ul style="list-style-type: none"> • All MCU pins accessible • USB Host+Func, RS232 • 2 x 7seg LEDs, buttons • 3V and 5V operation 		Starter Kit with MB9BF516N MCU (100pin MCU) and capacitive touch board <ul style="list-style-type: none"> • All MCU pins accessible • USB Host+Func, RS232 • 2 x 7seg LEDs, buttons • 3V and 5V operation • Optionally available with J-Link JTAG adapter
	Starter Kit with MB9BFD18T MCU(176pin MCU) <ul style="list-style-type: none"> • JTAG/USB adapter on board • All MCU pins accessible • Dual Ether/MAC I/F • USB Host+Func, RS232 • CAN • 2 x 7seg LEDs, buttons, rotary encoder, poti • 3V and 5V operation 		Adapter board for SK-FM3-100PMC-MB9BF516N <ul style="list-style-type: none"> • Allows the connection of Cypress's inverter boards like SK-POWER-3P-LV2-MC (not included) to the starter kit • Extension board for SK-FM3-100PMC-MB9BF516N (not included) Complete evaluation system consists of SK-FM3-100PMCMCMB9BF516N, ADA-FM3-100PMCMC, SK-POWER-3P-LV2-MC and a motor
	Starter Kit with MB9AFB44N MCU(100pin MCU) <ul style="list-style-type: none"> • JTAG/USB adapter on board • All MCU pins accessible • Segment LC display • USB Host+Func, RS232 • Buzzer • FRAM UHF RFID memory • Capacitive touch buttons • 3V and 5V operation 		

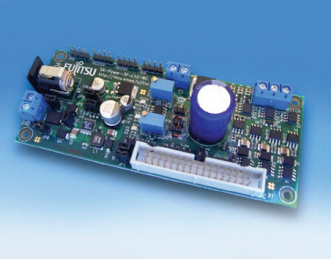
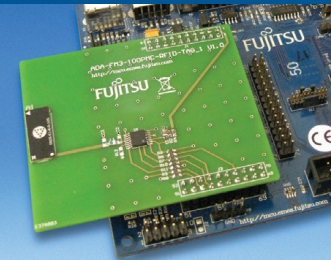
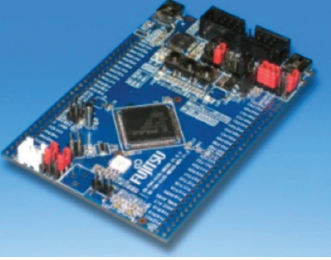
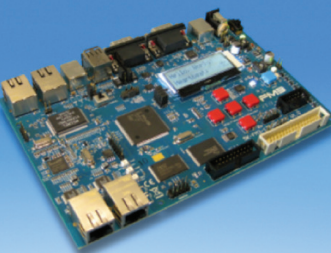
EVALUATION BOARDS

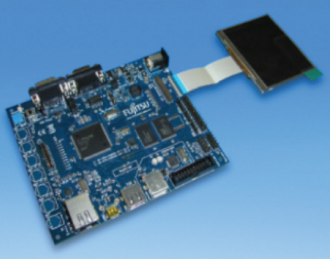
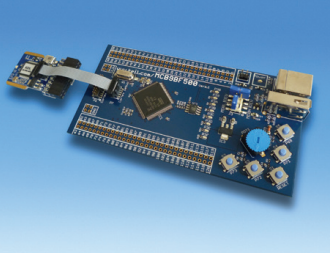
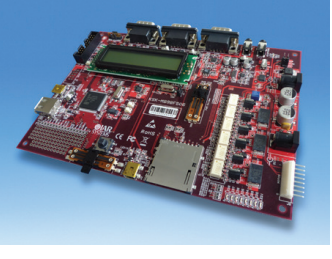
Tool	Features
 <p>SK-POWER-3P-LV2-MC</p>	<p>3-phase MOSFET Power Stage, 24V, 8A max.</p> <ul style="list-style-type: none"> Allows the connection of BLDC or PMSM motors (not included) Current and voltage measurements Temperature sensor and overvoltage/current detection with indicator LEDs Fits ADA-FM3-100PMC-MC, SK-FM3-176PMC-ETHERNET, SK-FM3-176PMC-FA, etc. (not included) <p>Complete evaluation system consists of MCU evaluation board (e.g., SKFM3-100PMC-MB9BF516N + ADAFM3-100PMC-MC), SK-POWER-3PLV2-MC and a motor</p>
 <p>ADA-FM3-100PMC-RFID-TAG1</p>	<p>UHF RFID Module with 4KByte FRAM</p> <ul style="list-style-type: none"> Extension board for SK-FM3-100PMC (not included) Based on dual-interface UHF RFID chip MB97R804B with SPI interface and 4KByte FRAM The memory can be accessed from the MCU via a SPI interface and via RFID reader/writer devices
 <p>SK-FM4-U120-9B560-MEM</p>	<p>Starter Kit with FM4 MB9BF568R MCU (120pin MCU)</p> <ul style="list-style-type: none"> All MCU pins accessible USB device (mini-USB Type B) CMSIS-DAP JTAG adapter on board RGB LED User buttons, potentiometer, reset button SD-card slot 3V and 5V operation Available with external 32MB NAND Flash and 16MB SDRAM (optional)
 <p>SK-FM3-176PMC-FA</p>	<p>Fieldbus Starter Kit with FM3 MB9BFD18T MCU (176pin MCU)</p> <ul style="list-style-type: none"> Covers various protocols EtherCAT, Powerlink, Profinet MODBUS TCP, Ethernet/IP 2 x CAN, USB User interface (push buttons, LCD module, RGB LED) External RAM and Flash memory Motor control interface Debug interface

Tool	Features
 <p>SK-FM3-176PMC-TFT SK-FM4-120PMC-TFT</p>	<p>TFT Direct-Drive Starter Kit with FM3 MB9BFD18T (176pin) or FM4 MB9BF568R (120pin) MCU</p> <ul style="list-style-type: none"> Includes QVGA color TFT display Ethernet, USB, CAN interfaces on board Cap touch buttons 8MB external Flash and 2MB external RAM
 <p>Keil MCB9BF500UME</p>	<p>Starter Kit with MB9BF506R MCU(120pin MCU) ULINK-ME JTAG adapter</p> <ul style="list-style-type: none"> Limited set of peripherals USB Host+Func. Buttons All MCU pins accessible
 <p>IAR Kickstart KSK-MB9BF506</p>	<p>Starter Kit with MB9BF506R MCU (120pin MCU) J-Link Lite (on board)</p> <ul style="list-style-type: none"> Many peripherals LCD SD card slot CAN, USB, RS232 Motor control power stage
 <p>SK-FM3-100PMC</p>	<p>FM3 MB9BF618T</p> <ul style="list-style-type: none"> All MCU pins accessible On-board JTAG adapter plus standard JTAG connector Trace connector USB Host and Device Dual Ethernet (2 connectors) Reset button, user button Power LED, user LED
 <p>IAR KickStart Kit for MB9BF516R</p>	<p>FM3 MB9BF516R</p> <ul style="list-style-type: none"> All MCU pins accessible On-board JTAG adapter plus standard JTAG connector Trace connector USB Host and Device Reset button, user button Power LED, user LED

CYPRESS FM FAMILY SOLUTIONS

In addition to other development tools, Cypress offers a range of solutions packages including FM Touch, FM Connect USB, FM Connect Ethernet, FM Inverter, FM Safety and FM Color.

FM Touch	FM Connect USB	FM Connect Ethernet	FM Inverter	FM Safety
<ul style="list-style-type: none"> Capacitive touch sensors Software solution, only one ADC channel per sensor channel Free library available Buttons and complex sensors (sliders, wheels) 	<ul style="list-style-type: none"> USB host and device Low level drivers Various USB class implementations Mass storage class, virtual COM port, HID mouse, HID keyboard LibUSB Covers embedded as well as PC side 	<ul style="list-style-type: none"> 10/100Mbps IEEE802.3 Ethernet Low-level drive Free TCP/IP stack implementations lwIP, uP Application layer, HTTP server, DHCP, SMTP, etc. 	<ul style="list-style-type: none"> Dedicated application library available Various software examples Various motor types supported 	<ul style="list-style-type: none"> IEC60730 class B IEC61508 SIL2 Self test libraries (STL) available Covers CPU, clock, interrupts, RAM, ROM, IO, ADC
<ul style="list-style-type: none"> MCUs: all FM family members Starter kits available 	<ul style="list-style-type: none"> MCUs: large selection of FM3 and FM4 devices Several evaluation boards available 	<ul style="list-style-type: none"> MCUs: various FM3 high-performance and FM4 devices TwinMAC derivatives available (2 Ethernet MAC on chip) Starter kit available 	<ul style="list-style-type: none"> MCUs: the majority of FM0+/FM3/FM4 family devices Up to 3 MFTs, QDU– quadrature decoder unit Starter kits and power stage 	<ul style="list-style-type: none"> MCUs: all FM family members Various HW features implemented on FM family MCUs CRC, watchdog, LVD, clock supervisor, etc.
FM Color	FM Connect Fieldbus	FM Thermal Printer		
<ul style="list-style-type: none"> Low-cost TFT direct drive Drives QVGA without external RAM Frame buffer concept for 'quasi-static' content TFT Wizard – code generator 	<ul style="list-style-type: none"> Sample implementation for fieldbus protocol slave supports: <ul style="list-style-type: none"> - Modbus TCP - Powerlink - EtherCAT - Profinet RT Open source stack implementations plus third-party offerings EtherCAT with ASIC ET1100 Switch/hub onboard 	<ul style="list-style-type: none"> Reference solution 2 inch print heads 60mm/s Voltage and heat safeguard Printer API Control GUI Barcode printing 		
<ul style="list-style-type: none"> MCUs: FM3 high-performance group, FM4 Dedicated evaluation boards available: SK-FM3-176PMC-TFT SK-FM4-120PMC-TFT 	<ul style="list-style-type: none"> MCUs: FM4, FM3 MB9BD10S/T, MB9B210S/T, MB9B610S/T series Dedicated evaluation board available: SK-FM3-176PMC-FA 	<ul style="list-style-type: none"> MCU: FM3 series MB9AF312K 		

CYPRESS FM TOUCH

FM Touch is a solutions package for capacitive touch applications based on any member of the FM0+, FM3 and FM4 families. FM Touch consists of a dedicated firmware library as well as a development GUI that runs on Windows PC. Documentation including application notes is available, as is sample software. Dedicated starter kits including initial hardware enable rapid project ramp-up.

Selected features support capacitive touch buttons, sliders, scroll wheels, x/y matrix and proximity sensing

- Uses one ADC input pin per touch channel, no additional hardware required
- High sensitivity (<<10ff), high dynamic range and SNR (signal to noise ratio)
- Solid front panels or a multi-layer front panel possible
- Automatic offset calibration and crosstalk suppression
- Optimized RAM/ROM footprint for embedded applications

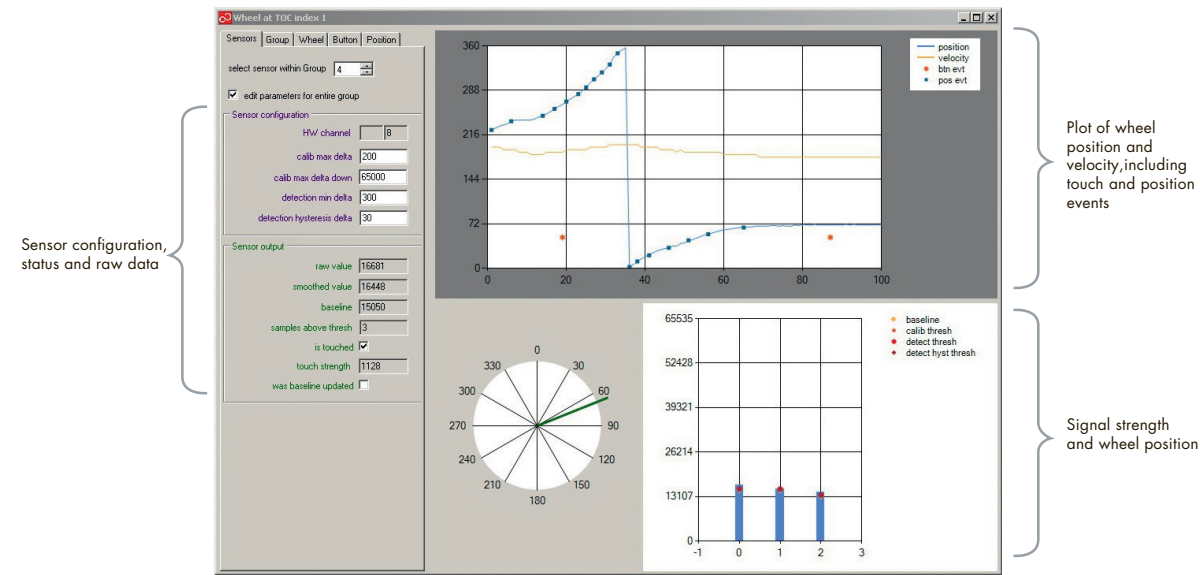

CYPRESS FM CONNECT USB

The FM Connect USB platform is a set of hardware and software components, tools and documentation. The package supports multiple, out-of-the-box, embedded USB solutions and both HOST and DEVICE use cases.

Selected FM Connect USB features

- Support for up to two USB interfaces per MCU
- Support for USB host/function or dual role
- USB Wizard, as code generator for USB firmware
- USB device functions, virtual COM, HID mouse/joystick/data communication, Lib USB COM
- USB host functions, HID mouse/keyboard, USB mass storage
- PC drivers: LibUSB and Windows native driver support
- Can be used with all FM family microcontrollers with on-chip USB hardware

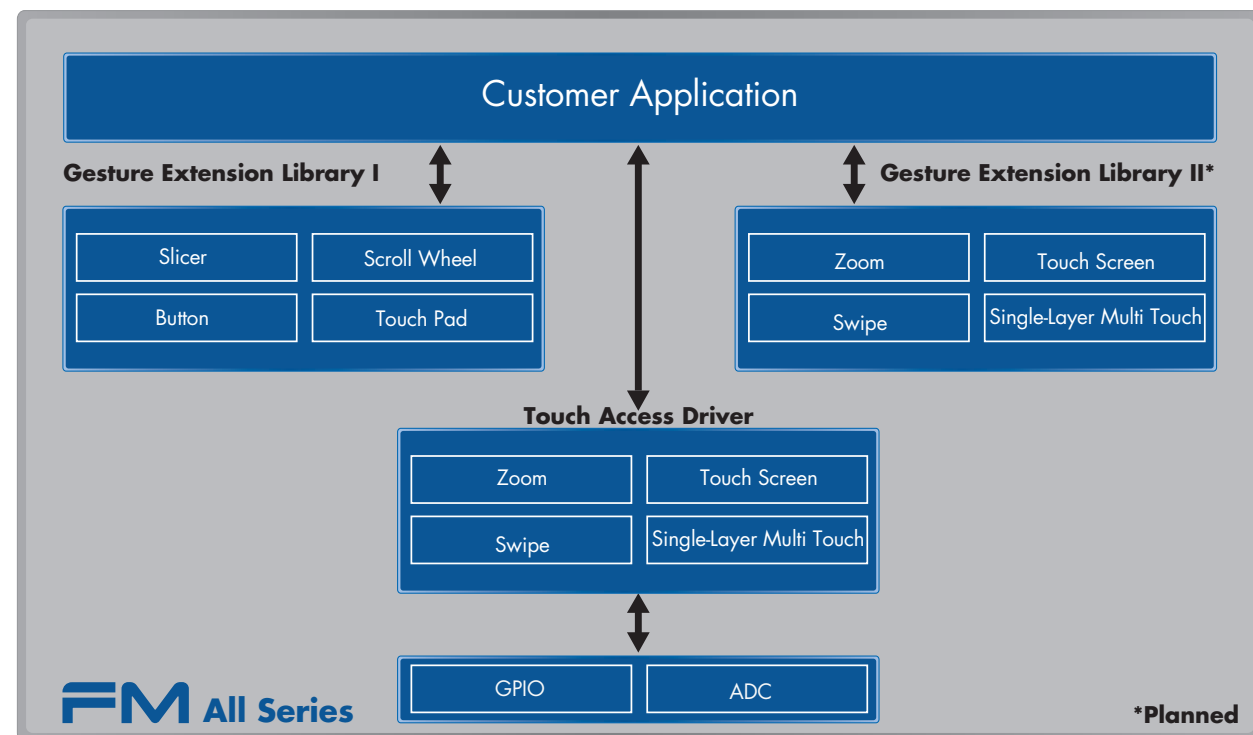
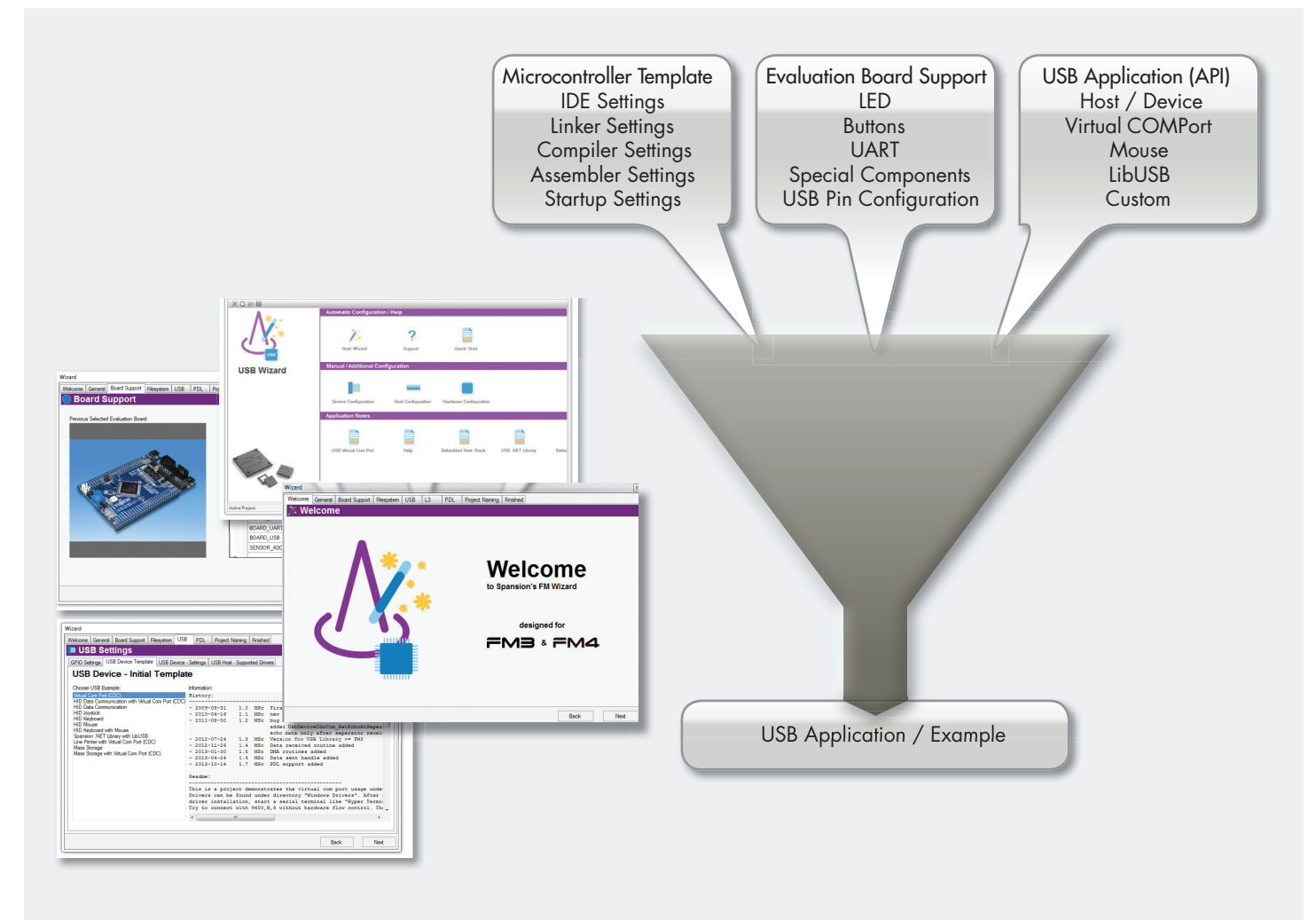

CYPRESS FM CONNECT ETHERNET

The FM Connect Ethernet package utilizes proven open source components such as the lwIP TCP/IP stack and internal developments such as the L3 FM low-level library. This enables the rapid implementation of solutions such as web-based diagnostic systems or maintenance interfaces for industrial devices.

Selected FM Connect Ethernet features

- Up to 2-channel Ethernet
- Software switch module
- Low-level driver, TCP/IP stacks
- Sample software, web server, etc.
- Commercial products from partners (e.g., Sevenstax)

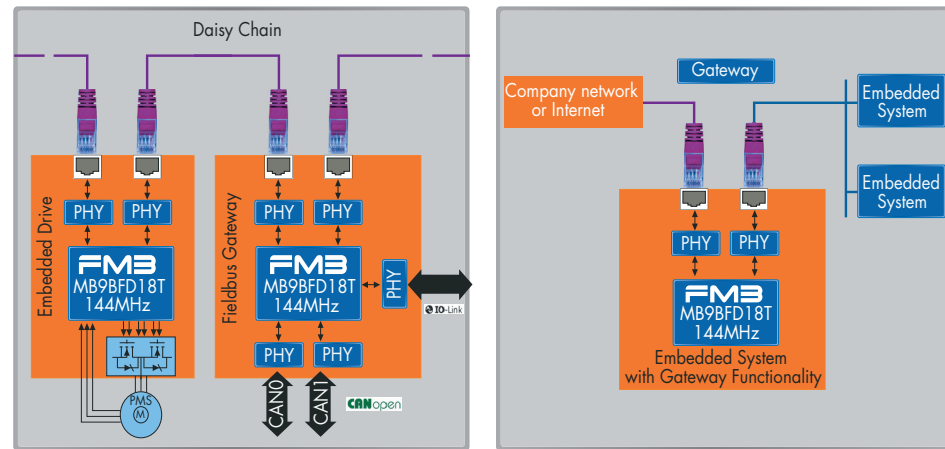

CYPRESS FM COLOR

FM Color, a solution for simple and cost-efficient, full-color HMIs, enables designers to add colored HMI functionality/TFT display control to designs without needing additional hardware. An FM3 or FM4 MCU controls both the application and the TFT display; no dedicated graphic controller is needed. The TFT display can be directly connected to FM3/FM4 MCUs.

Selected FM Color features

- Up to 320x240 pixel, 8-bit color depth with internal RAM
- Up to 480x272, 16-bit color with external SRAM (8-bit or 16-bit external bus)
- Firmware module TFT driver to generate the timing signals to control the TFT display, handle the data flow from RAM to TFT, and synchronize the update of the TFT content with the display timing
- Predefined HMI objects: e.g., simple buttons, checkboxes, text and progress bars
- Control routines for user interaction via buttons, a USB mouse, keyboard or touchscreen
- PC-based, simple scene generator "TFT wizard"

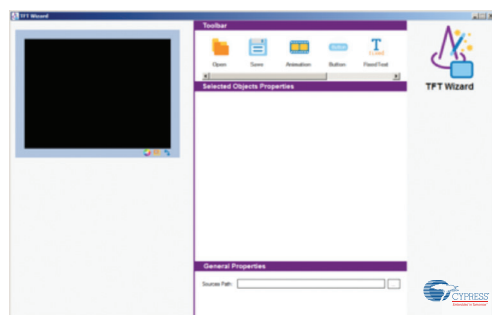
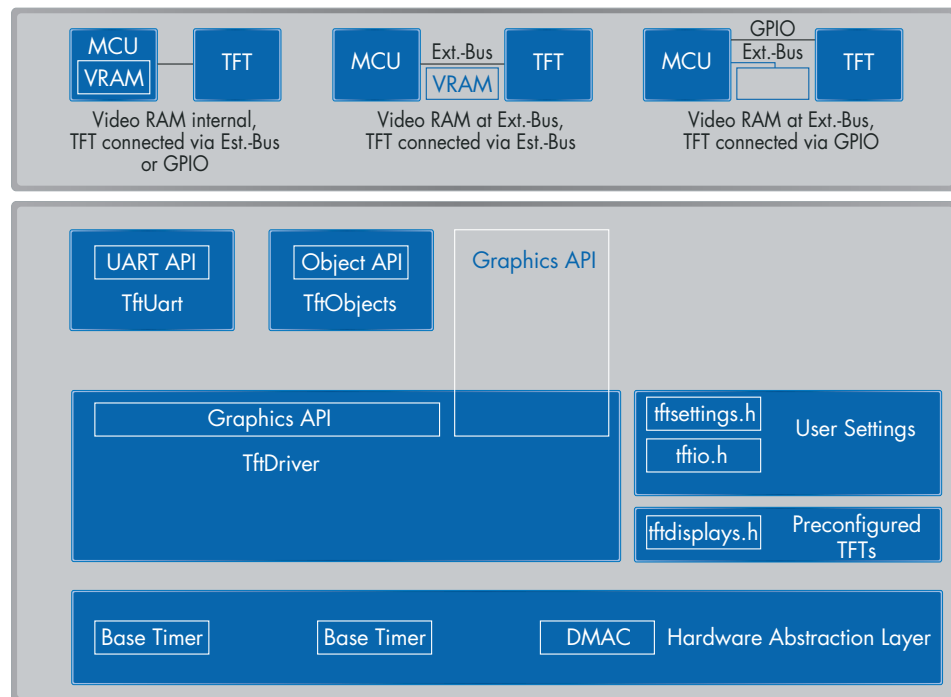

CYPRESS FM SAFETY

To help customers obtain relevant safety certifications, Cypress embeds specific hardware components into its FM family of MCUs. Self-test libraries for IEC61508 and IEC60730 standards available.

Software packages: Self-Test Libraries (STL)

- Addresses IEC60730 class B and IEC61508 requirements
- Pre-operation self-test (POST): system startup
- Built-in self-test (BIST): run periodically
- APIs include CPU, Clock, RAM, flash, interrupt, ADC, GPIO test routines
- Utilizes the functional safety hardware features
- IEC60730 STL memory footprint: approximately 4.6KB flash (max.), 80-bytes RAM usage
- ICE61508 (SIL2) version available on request

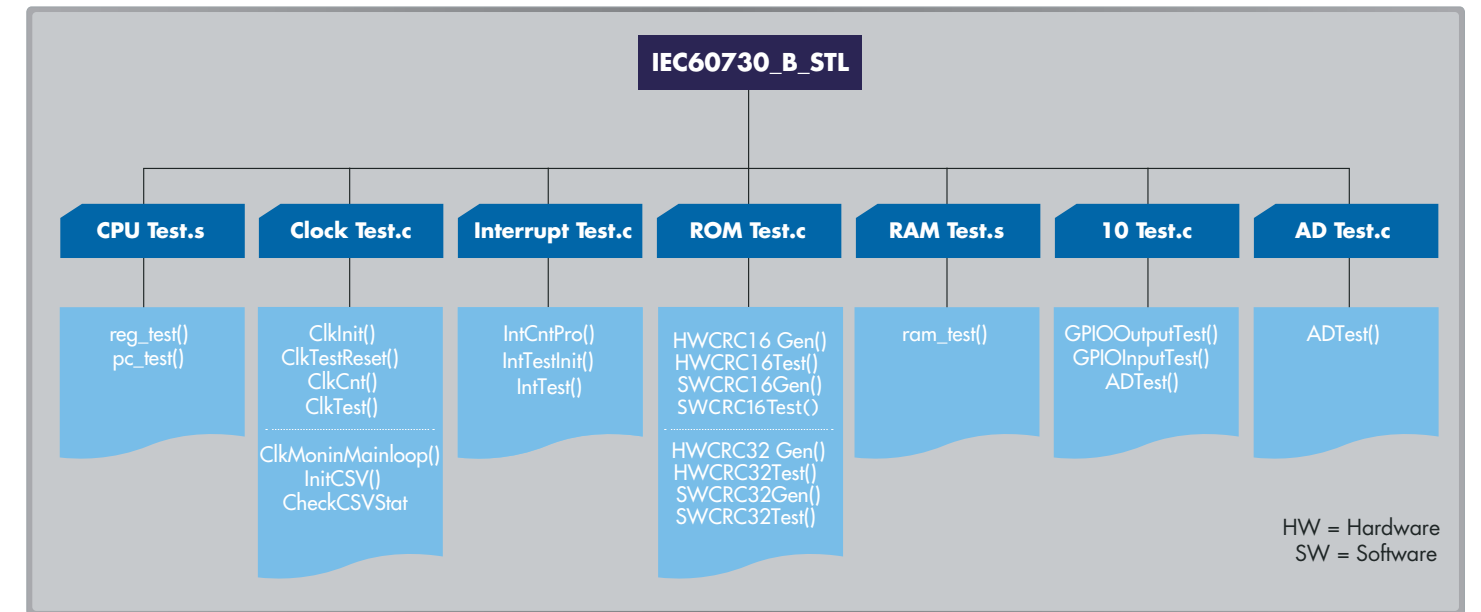

CYPRESS FM INVERTER

FM Inverter is a solution to drive three-phase motors such as PMSM with the FM family. The package consists of firmware for different motor and control types, a GUI for parameterization, documentation, software examples, dedicated starter kits and support.

Selected FM Inverter features

- Up to 3-channel, flexible 3-phase motor timers on 144MHz FM3 MCUs
- Automatic dead-time insertion, freely programmable ADC trigger
- Up to three independent 12-bit 1Msps ADC units, with up to 32 ADC inputs
- Up to 3-channel ABZ quadrature decoder units
- DTTI input for emergency motor stop
- 3.3V and true 5V single-supply operation
- Dedicated starter kit and power stage extension board available
- Ready-to-run sample software for different motor types
- GUI for PC-based parameterization
- Can be used with all FM3 microcontrollers except the low-power group

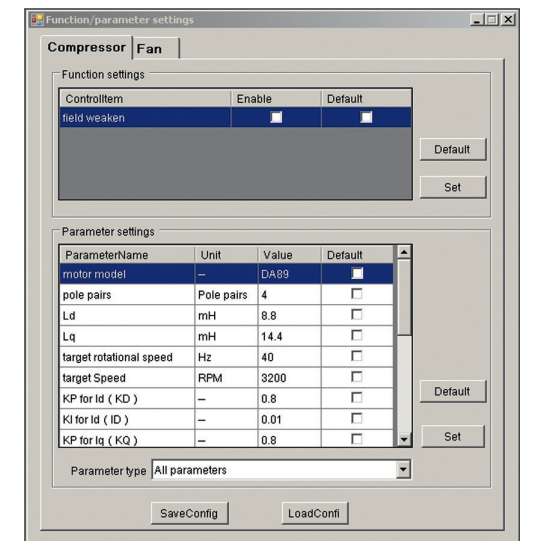

ADDITIONAL SOLUTIONS

- Inverter motor control solution for consumer electronics such as air conditioners, refrigerators and washing machines
- RF solution for RF control, sensor control and NFC
- ESL (virtual simulation) to identify fatal errors and to shorten the debugging and development time
- Audio/video solutions

Check Cypress's seminar page in the news section of our website for workshops and other application-development support.

White Goods

- Products: washing machines, dishwashers, air conditioners
- MCUs: FM0+ and FM3 basic group
- Cost-optimized products
- Reliable flash for EEPROM emulation
- On-chip RC oscillator: = -2%
- Hardware motor control support
- 2 or 3 fast, independent, 12-bit ADCs
- Wide supply voltage range: 2.7-5.5V
- Operating temperature range between -40°C and +105°C

Factory Automation

- Products: PLCs, motor control, sensors
- MCUs: FM3 high-performance and basic groups, and FM4
- High performance
- Up to 200MHz CPU clock
- DSP functionality on FM4
- FPU on FM4
- Faster flash in group: 14ns access + code pre-fetch = OWS at 144MHz
- Up to 1.5MB flash
- Wide supply voltage range: 2.7-5.5V
- Hardware motor control support, up to three motors, including software package
- Three independent, fast, 12-bit ADCs
- Many safety features (e.g., MPU, CRC, two-stage LVD)
- Twin AMC – dual-Ethernet device
- Scalable lineup, pin compatibility between high-performance and basic groups MCUs to cover a wide range of applications
- Many devices suitable for extended temperature ranges between -40°C and +105°C

Medical and Handheld Devices

- MCUs: FM0+ and FM3 low-power and ultra-low-leakage groups
- Ideal feature mix for HMI (human machine interface)
- LCD segment controller
- High-performance, capacitive touch software library
- USB host and function (OTG functionality), including corresponding software packages
- Two independent, fast, 12-bit ADCs
- Low-voltage supply: 1.65-3.6V
- Low-current consumption and deep standby modes

Motor/Inverter Control

- MCUs: FM4 family
- High-spec vector arithmetic
- Single-cycle instruction by DSP
- Enhanced motor control timer
- Enhanced A/D convertor
- High-speed sampling (conversion speed: 2Msps)
- Window comparator

Networking

- MCUs: FM4 and FM3 high-performance families
- Enriched communication function
- SD card I/F (SDIO)
- Ethernet, CAN
- High-speed 12C fast mode (~1Mbps)
- High-speed SPI (~20Mbps)
- Large memory
- SDRAM I/F
- DSTC (descriptor system data transfer controller, maximum: 1,024ch)

WHY CYPRESS?

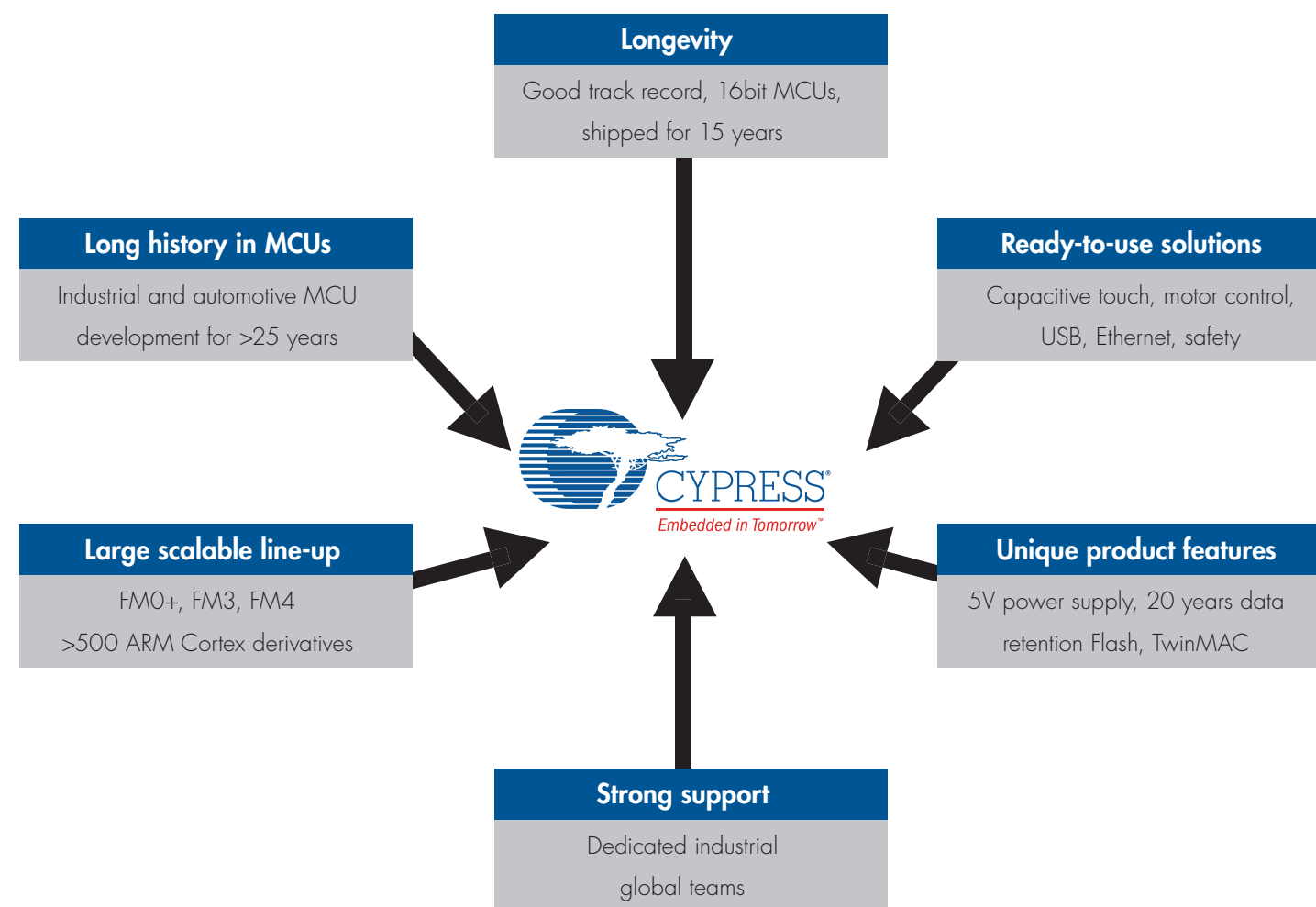

CONTACT US

CYPRESS HEADQUARTERS

Cypress Semiconductor Corporation

198 Champion Court
San Jose, CA 95134 USA
Tel: +1 (408) 943-2600
Fax: +1 (408) 943-6848
Toll-free: +1 (800) 858-1810 (U.S. only)

www.cypress.com
<http://www.cypress.com/products>

FOR MORE INFORMATION ON AUTOMOTIVE SOLUTIONS:

www.cypress.com/applications/automotive-solutions

CYPRESS EDUCATION—UNIVERSITY ALLIANCE

www.cypress.com/university

ONLINE TECHNICAL SUPPORT

www.cypress.com/support

CYPROS® CERTIFIED CONSULTANTS

www.cypress.com/design-partner-program

TRAINING—WORKSHOPS/WEBINARS/ON-DEMAND

www.cypress.com/trainings

CYPRESS ONLINE STORE

www.cypress.com/cypress-store

CYPRESS DEVELOPER COMMUNITY™

www.cypress.com/cdc

ABOUT CYPRESS

Cypress delivers high-performance, mixed-signal, programmable solutions that provide customers with rapid time-to-market and exceptional system value. Cypress offerings include the PSoC Programmable System-on-Chip, USB controllers, general-purpose programmable clocks, and memories. Cypress also offers wired and wireless connectivity solutions ranging from its CyFi low-power RF solution, to West Bridge and EZ-USB FX2LP controllers that enhance connectivity and performance in multimedia handsets. Cypress serves numerous markets, including consumer, computation, data communications, automotive and industrial. Cypress trades on the NYSE under the ticker symbol CY. Visit Cypress online at www.cypress.com.

© 2014 -2016 Cypress Semiconductor Corporation. All rights reserved.

All trademarks are the property of their respective owners.

002-04317 Rev. *A

